

CATALOGUE

REE
MODELES
La différence...

Édition 2020

Échelle HO

HO Scale - Spur HO







CC-7100 ACCESS	p.4-5	Voiture PLM Métallisée.....	p.56-57
Draisine DU-65	p.6-7	Voiture Bacalan série3	p.58-59
Locotracteur MOYSE.....	p.8-9	Voiture Bacalan	p.60
Locotracteur Y-2100.....	p.10-11	Voiture DEV AO.....	p.61
Autorail VH.....	p.13	Voiture DEV AO U46	p.62-63
BB-67400	p.14-15	Voiture Sud-Ouest série2.....	p.64-65
BB-67000	p.16-17	Voiture Sud-Ouest série3.....	p.66-67
CC-7100 Record du Monde.....	p.18-19	Voiture UIC.....	p.68-70
BB-9200 série1	p.20-21	Voiture UIC Couchettes.....	p.71-75
BB-9200 série2	p.22		
BB-16000 série1.....	p.23	Wagon Kangourou.....	p.76-77
030-TU série2.....	p.24-25	Wagon Coke.....	p.78-79
141-E/F série2	p.26-27	Wagon Citerne OCEM.....	p.81
231 série6.....	p.28-29	Wagon Citerne ANF	p.82
231 série7.....	p.30-31	Wagon Plat PLM	p.83
T-16.1 ex-Allemande	p.32-33	Wagon TP Plat	p.84-85
		Wagon TP Couvert	p.86
Fourgon OCEM 29 série3.....	p.34-35	Wagon TP Frigo	p.87
Fourgon OCEM 32 série1.....	p.36-37	Wagon TP Frigo série2.....	p.88-89
Fourgon OCEM 32 série2.....	p.38-39	Wagon Céréancier Richard série1.....	p.90-91
Fourgon DEV 52 série1	p.40-41	Wagon Céréancier Richard série2.....	p.92-93
Fourgon Bogies ex-PLM série1.....	p.42-43	Wagon Tombereaux série3.....	p.94-95
Fourgon Bogies ex-PLM série2.....	p.44-45	Wagonnet draisine série2.....	p.96-97
OCEM RA série1	p.46-47	Wagon Trémie EX série5	p.98-99
OCEM RA série2.....	p.48-49	Wagon Citerne ANF série7.....	p.100-101
Postale 21m série4	p.50-51	Wagon UFR Bi-Porteur	p.102-103
Postale 21m série5	p.52-53	Wagon Plat Charges lourdes.....	p.104
Postale 16m série2	p.54-55		



RAILS EUROP EXPRESS crée la gamme REE ACCESS, avec pour objectif, la fabrication de modèles simplifiés de qualité. Le prix de ces modèles, rend accessible la gamme REE ACCESS au plus grand nombre.

REE ACCESS line is created by RAILS EUROP EXPRESS. The goal is to produce quality simplified models. With those models' prices, the REE ACCESS line is made accessible to the greatest number.

RAIL EUROP EXPRESS erstellt die REE ACCESS Reihe mit dem Ziel, einfache Modelle von hoher Qualität herzustellen. Der Preis dieser Modelle macht die REE ACCESS Linie für möglichst viele zugänglich.



Ref.JM-001 - CC-7150 Original condition SNCF SUD-EST Lyon Mouche « MISTRAL » DC Analog, Ref.JM-001 S - CC-7150 Original condition SNCF SUD-EST Lyon Mouche « MISTRAL » DCC Sound, Ref.JM-001 SAC - CC-7150 Original condition SNCF SUD-EST Lyon Mouche « MISTRAL » AC Sound

Ref.JM-001 - CC-7150 Originalfassung Elektrolok, SUD-EST, Lyon Mouche BW « MISTRAL » Analog, Ref.JM-001 S - CC-7150 Originalfassung Elektrolok, SUD-EST, Lyon Mouche BW « MISTRAL » DCC Sound, Ref.JM-001 SAC - CC-7150 Originalfassung Elektrolok, SUD-EST, Lyon Mouche BW, « MISTRAL » AC Sound

**Locomotive électrique
CC-7150**

Origine Sud-Est Lyon Mouche
"MISTRAL"
JM-001 Analogique
JM-001S : DCC Sound
JM-001 SAC : AC Sound



Ref.JM-002 - CC-7120 Original condition SNCF SUD-OUEST Paris SO DC Analog, Ref.JM-002 S - CC-7120 Original condition SNCF SUD-OUEST Paris SO DCC Sound, Ref.JM-002 SAC - CC-7120 Original condition SNCF SUD-OUEST Paris SO AC Sound

Ref.JM-002 - CC-7120 Originalfassung Elektrolok, SUD-OUEST, Paris SO BW, Analog, Ref.JM-002 S - CC-7120 Originalfassung Elektrolok, SUD-OUEST, Paris SO BW, DCC Sound, Ref.JM-002 SAC - CC-7120 Originalfassung Elektrolok, SUD-OUEST, Paris SO BW, AC Sound

**Locomotive électrique
CC-7120**

Origine Sud-Ouest Paris S.O.
JM-002 Analogique
JM-002S : DCC Sound
JM-002 SAC : AC Sound



**Locomotive électrique
CC-7117**

RG marquages blancs
Avignon
JM-003 Analogique
JM-003S : DCC Sound
JM-003 SAC : AC Sound



Ref.JM-003 - CC-7117 RG retrofit White markings, Avignon DC Analog, Ref.JM-003 S - CC-7117 RG retrofit White markings, Avignon DCC Sound
Ref.JM-003 SAC - CC-7117 RG retrofit White markings, Avignon AC Sound,

Ref.JM-003 - CC-7117, Allgemeine Überarbeitung Elektrolok, Weißen Beschriftungen, Avignon BW, Analog, Ref.JM-003 S - CC-7117, Allgemeine Überarbeitung Elektrolok, Weißen Beschriftungen, Avignon BW, DCC Sound, Ref.JM-003 SAC - CC-7117, Allgemeine Überarbeitung Elektrolok, Weißen Beschriftungen, Avignon BW, AC Sound

**Locomotive électrique
CC-7139**

GRG marquages jaunes
Avignon
JM-004 Analogique
JM-004S : DCC Sound
JM-004 SAC : AC Sound



Ref.JM-004 - CC-7139 GRG retrofit Yellow markings, Avignon DC Analog, Ref.JM-004 S - CC-7139 GRG retrofit Yellow markings, Avignon DCC Sound, Ref.JM-004 SAC - CC-7139 GRG retrofit Yellow markings, Avignon AC Sound

Ref.JM-004 - CC-7139, Allgemeine Überarbeitung Elektrolok, gelben Beschriftungen, Avignon BW, Analog, Ref.JM-004 S - CC-7139, Allgemeine Überarbeitung Elektrolok, gelben Beschriftungen, Avignon BW, DCC Sound, Ref.JM-004 SAC - CC-7139, Allgemeine Überarbeitung Elektrolok, gelben Beschriftungen, Avignon BW, AC Sound



CC-7100 ACCESS
Locomotive électrique • Electric locomotive • Elektriklokomotive



La série 3 des draisines DU65, est axée sur la reproduction de matériel particulier avec une draisine Chasse-neige (Réf. MB-108), une autre machine avec Grue de levage (Réf. MB-109), la machine Brosseuse bleue plus moderne (Réf. MB-110) et le modèle de la RATP dans son état d'origine avec petit capot à la base de la cheminée, phares à disque et toit rouge (Réf. MB-111). Tous ces modèles sont reproduits de façon industrielle avec une très grande finesse pour la première fois à cette échelle.

The DU65 Draisines series 3 focuses on specific vehicles including a Snowplow Draisine, (Réf. MB-108), another one fitting a hoisting crane (Réf. MB-109), a more modern tracks scrubber (Réf. MB-110) and the model of the RATP in its original condition with early type lights, small hood at the exhaust base and red roof (Réf. MB-111). All these models are reproduced for the first time at HO scale using industrial processes with maximum accuracy.

Die 3. Serie der DU 65 Draisine konzentriert sich auf die Reproduktion von Spezialmaterial mit einem Schneepflug Draisine (Ref. MB-108), einer weiteren Maschine mit Hubkran (Ref. MB-109), der moderneren Blaubürstenmaschine (Ref. MB-110), und das Modell der RATP im Original-Zustand mit kleiner Haube am Kaminboden, Scheibenleuchten und rotem Dach (Ref. MB-111). Alle diese Modelle werden zum ersten Mal in diesem Maßstab industriell mit sehr großer Genauigkeit reproduziert.



Draisine DU65 6 132 - "Chasse-Neige" - Toit crème, phares à pincettes, logo ancien, Ep.IV-V
MB-108 Analogique - MB-108S DCC sonorisée

DU65 Draisine 6 132 « SUD-EST » Snowplow, cream roof, modern headlights, boxed SNCF logo, Ep.IV-V, Réf. MB-108 - DC Analog, Réf. MB-108 S - DCC Sound • DU65 Draisine 6 132 SUD-EST « Schneepflug » Cremweißes Dach, alte SNCF Zeichnung, Ep.IV-V, Analog

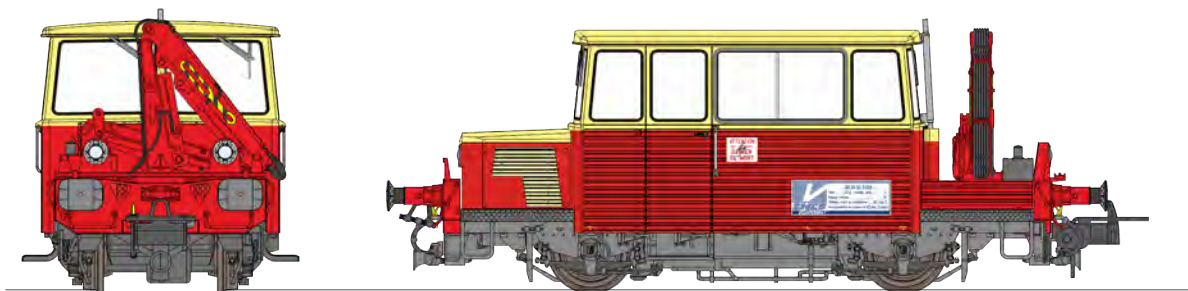

Draisine DU65 6 049 - OUEST avec grue - Toit crème, phares à pincettes, logo encadré, Ep.IV-V
MB-109 Analogique - MB-109S DCC sonorisée

DU65 Draisine 6 049 « OUEST » with hoisting CRANE, cream roof, modern headlights, boxed SNCF logo, Ep.IV-V, Réf. MB-109 - DC Analog, Réf. MB-109S - DCC Sound • DU65 Draisine 6 049 OUEST, mit Hubkran, Cremweißes Dach, Ep.IV-V, Analog



Draisine DU65 6 118 - SUD-EST, brosseuse - Bleue et blanche, phares à pincettes, logo ancien, Ep.V
MB-110 Analogique - MB-110S DCC sonorisée

DU65 Draisine 6 118 « SUD-EST », Tracks Scrubber, Blue/White livery, modern headlights, Ep.IV-V, Réf. MB-110 - DC Analog, Réf. MB-110 S - DCC Sound, DU65 Draisine 6 118 SUD-EST Bürstenmaschine, blau / Weiß Lackierung, Ep.V, Analog



Draisine DU65 T-151 - RATP - Toit rouge, phares à pincettes, logo encadré, Ep.III-IV
MB-111 Analogique - MB-111S DCC sonorisée

RATP DU65 Draisine T 151, RED roof, Early type headlights, Ep.III-IV, DC Analog, Réf. MB-111 - DC Analog Réf. MB-111 S - DCC Sound, RATP T 151 DU 65 Draisine, rotes Dach, Ep.III-IV, Analog

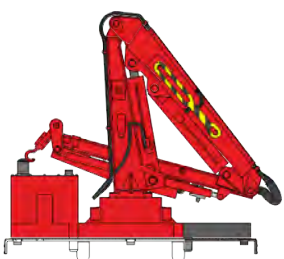

Grue pour draisine

Set de grue de levage pour draisine, engins de chantier
XB-851

*Hoisting Crane for Draisine and construction vehicles
 Draisine Hubkranset*

DU-65
Draisine



La série 3 des locotracteurs MOYSE comporte un retraitage du modèle Ep.III avec ancienne lanterne SNCF (référence MB-050) et du modèle SNCF Ep.IV vert 301 et bande jaune (MB-078) très vite épuisés lors du premier tirage. Les autres modèles sont de vraies nouveautés (nouvelle gravure de moule) et présentent une cabine fermée.

The Moyses shunters series 3 includes a new run of the Ep.III model with ancient SNCF lantern (référence MB-050) and of the SNCF Ep. IV model, SNCF 301 green with yellow strip (MB-078) as it was soon out of stock. The other models from this series are totally new (new mould engraving) and are showing a closed driver cabin.

Die 3. Moyses Rangierlok Serie enthält das SNCF Modell Ep.III mit alter SNCF-Laterne (Referenz MB-050) und das SNCF Modell Ep.IV grün 301 und gelb (MB-078), die in der ersten Produktion sehr schnell ausverkauft waren. Die restlichen Modelle sind echte Neuheiten und haben eine geschlossene Fahrerkabine.

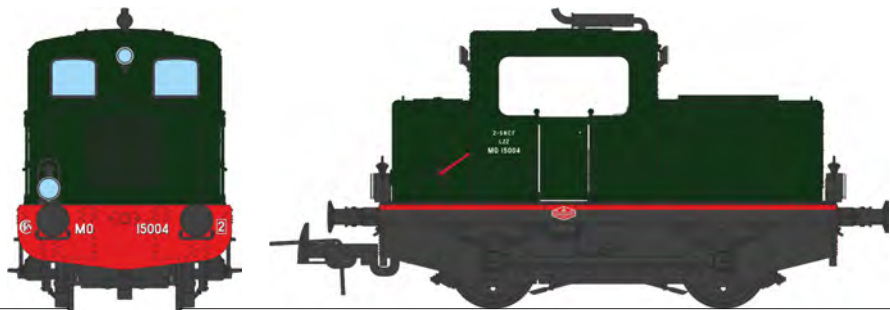

MOYSE Y32 TDE

Origine, SNCF vert 306
Ep. III, traverses rouges,
lanternes anciennes
MB-050 Analogique
MB-050S : DCC Sound Power Pack

MOYSE 32 TDE, Original condition, SNCF green 306 Ep.III, red front beam, ancient lanterns, Réf. MB-050 - DC Analog, Réf. MB-050 S - DCC Sound, Power Pack, SNCF MOYSE 32 TDE Originalfassung Rangierlok, 306 grün Lackierung, alte Laterne, Ep. III

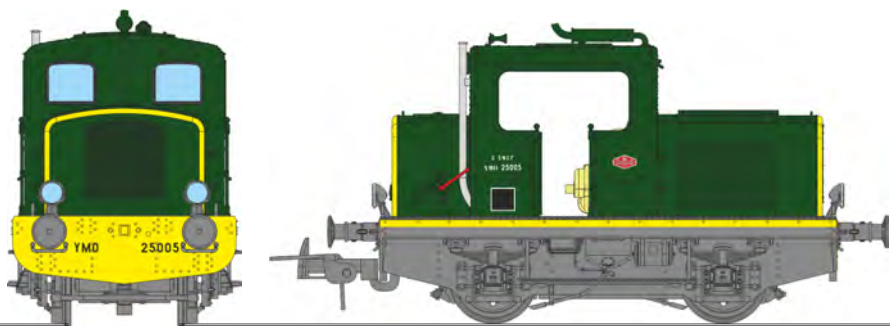

MOYSE Y32 TDE

SNCF vert 301, traverses et bandes de
visibilité jaunes, phares Marchal
MB-078 Analogique
MB-078S : DCC Sound Power Pack

MOYSE 32 TDE, SNCF green 301 Ep.IV, Yellow front beam and visibility strips, Marchal headlights, Réf. MB-078 - DC Analog, Réf. MB-078 S - DCC Sound, Power Pack, SNCF MOYSE 32 TDE Rangierlok, 301 grün Lackierung mit gelben Streifen, Marchal Laterne, Ep. IV



MOYSE Y32 TDE

Industriel ex-SNCF,
Ciments LAFARGE
Ep. IV-V
MB-122 Analogique
MB-122S : DCC Sound Power Pack

MOYSE 32 TDE, private plant Ex-SNCF, Ciments LAFARGE Ep.IV-V, Réf. MB-122 - DC Analog, Réf. MB-122 S - DCC Sound, Power Pack Ex-SNCF MOYSE 32 TDE Industrierangierlok, « Ciment LAFARGE », Ep. IV-V



MOYSE Y32 TDE

Industriel, Cabine fermée,
jaune - rouge, Ep. III-IV-V

MB-123 Analogique

MB-123S : DCC Sound Power Pack

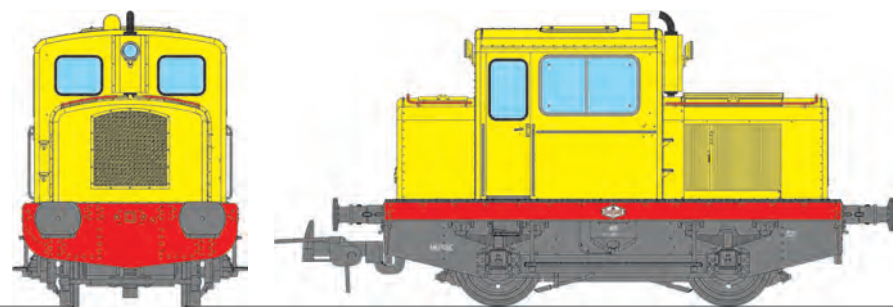

MOYSE 32 TDE, private plant closed cabin Yellow/ Red Ep.III-IV-V, Réf. MB-123 - DC Analog, Réf. MB-123 S - DCC Sound, Power Pack
MOYSE 32 TDE Industrierangierlok, geschlossene gelb / rot Fahrerkabine, Ep. III-IV-V

MOYSE Y32 TDE

ex-SNCF, "STEF"
Ep. IV-V

MB-124 Analogique

MB-124S : DCC Sound Power Pack



MOYSE 32 TDE, private plant Ex-SNCF « STEF » Ep.IV-V, Réf. MB-124 - DC Analog, Réf. MB-124 S - DCC Sound, Power Pack
Ex-SNCF MOYSE 32 TDE Industrierangierlok, « STEF », Ep. IV-V

MOYSE Y32 TDE

Industriel ex-SNCF,
ferrailleur "GOUTTE" Lausanne
Ep. IV-V

MB-125 Analogique

MB-125S : DCC Sound Power Pack



MOYSE 32 TDE, private plant Ex-SNCF Scrap merchant « GOUTTE » Lausanne Ep.IV-V, Réf. MB-125 - DC Analog, Réf. MB-125 S - DCC Sound, Power Pack, Ex-SNCF MOYSE 32 TDE Industrierangierlok, « GOUTTE » Schrotthändler, Lausanne, Ep. IV-V





Les modèles DCC Sound sont équipés d'une réserve d'énergie comme le Moysse et d'une mécanique 3 points améliorée pour tous les modèles, avec palier laiton.

The DCC sound models are fitting a Power Pack as our Moysse shunter and -for all models- an improved 3 points mechanism with brass made bearing.

Die DCC Sound Modelle sind mit einem Powerpack und - für alle modellen- einer verbesserten Dreipunktmechanik mit Messinglager ausgestattet.

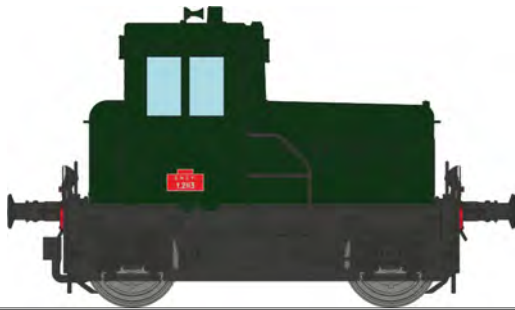

Y-2113 Origine

SNCF vert 306
Traverses rouges, Sud-Ouest, Ep. III
MB-144 Analogique
MB-144S : DCC Sound

Y 2113 Original condition, SNCF 306 green, red front beam, « Sud-Ouest » Ep.III, Réf. MB-144 - DC Analog, Réf. MB-144S - DCC Sound
Y 2113 Originalfassung Rangierloks, 306 grün, Sud-Ouest, Ep. III



Y-2101 Origine

SNCF vert 306
Traverses rouges, Sud-Est, Ep. III
MB-145 Analogique
MB-145S : DCC Sound

Y 2101 Original condition, SNCF 306 green, red front beam, « Sud-Est » Ep.III, Réf. MB-145 - DC Analog, Réf. MB-145S - DCC Sound
Y 2101 Originalfassung Rangierloks, 306 grün Lackierung, Sud-Est, Ep. III

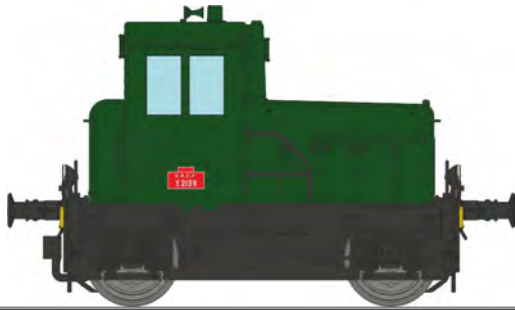

Y-2139

SNCF vert 301
Traverses jaunes, Nord, Ep. III-IV
MB-145 Analogique
MB-146S : DCC Sound

Y 2139 SNCF green 301, yellow front beam, « Nord » Ep.III/IV, Réf. MB-146 - DC Analog, Réf. MB-146S - DCC Sound
Y 2139 Rangierloks, 301 grün Lackierung, Nord, Ep. III-IV



Y-2103

SNCF vert 301
Traverses et bandes jaunes,
chassis noir, Sud-Est, Ep. IV
MB-147 Analogique
MB-147S : DCC Sound

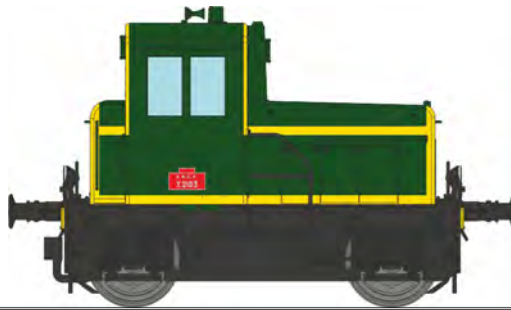

Y 2103 SNCF green 301, yellow front beam, yellow strips, black frame, « Sud-Est » Ep.IV, Réf. MB-147 - DC Analog, Réf. MB-147S - DCC Sound,
Y 2103 Rangierlok, 301 grün Lackierung mit gelben Streifen, schwarzen Rahmen, Sud-Est, Ep. IV

Y-2110

SNCF vert 301
Traverses et bandes jaunes,
chassis gris, Méditerranée, Ep. IV
MB-148 Analogique
MB-148S : DCC Sound

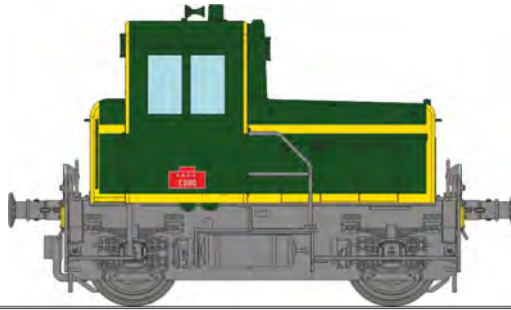

Y 2110 SNCF green 301, yellow front beam, yellow strips, grey frame, « Méditerranée » Ep.IV, Réf. MB-148 - DC Analog, Réf. MB-148S - DCC Sound
Y 2110 Rangierlok, 301 grün Lackierung mit gelben Streifen, grauen Rahmen, Méditerranée, Ep. IV

Y-2126

Industriel bleu
Traverses blanches, chassis noir,
Sud-Est, Ep. IV-V-VI
MB-149 Analogique
MB-149S : DCC Sound



Y 2126 Industrial plant shunter blue livery, white front beam, black frame, Ep.IV/V-VI, Réf. MB-149 - DC Analog, Réf. MB-149S - DCC Sound
Y 2126 Industrierangierlok, blau Lackierung, Schwarzen Rahmen, Ep. IV-V-VI

Y-2100
Locotracteur · Shunter · Rangierlok





Autorail VH X-2116
ex-PLM MONTLUÇON,
Rubis-Gris Perle, fanaux
d'angle et chasse pierres

MB-117S DCC sonorisé

VH railcar X-2116 ex-PLM MONTLUÇON, Ruby/Pearl Grey, top corner headlights and snowplow
Ex-PLM X-2116 VH Dieseltriebwagen MONTLUÇON, Rubinrot-Perlgrau, Ecklichten und Schienenräumer



Autorail VH X-2326
ex-ETAT BATIGNOLLES,
Rubis-Gris Perle, fanaux
d'angle

MB-118 Analogique
MB-118S DCC sonorisé

VH railcar X-2326 ex-ETAT BATIGNOLLES, Ruby/Pearl Grey, top corner headlights
Ex-ETAT X-2326 VH Dieseltriebwagen BATIGNOLLES, Rubinrot-Perlgrau, Schienenräumer



Autorail VH X-2114
ex-PLM LYON-VAISE,
Rubis-Gris Perle, fanaux
d'angle et chasse pierres

MB-119 Analogique
MB-119S DCC sonorisé

VH railcar X-2114 ex-PLM LYON-VAISE, Ruby/Pearl Grey, top corner headlights and snowplow
Ex-PLM X-2114 VH Dieseltriebwagen LYON-VAISE, Rubinrot-Perlgrau, Ecklichten und Schienenräumer



Autorail VH X-2119
ex-PLM AVIGNON,
Rouge et crème, feu
d'angle et chasse pierres

MB-120S DCC sonorisé

VH railcar X-2119 ex-PLM AVIGNON, Red/Cream, top corner headlights and cowcatcher snowplow
Ex-PLM X-2119 VH Dieseltriebwagen AVIGNON, Rot-Cremweiß, Ecklichten und Schienenräumer



Autorail VH X-2330
ex-ETAT NÎMES,
Rouge et crème, chasse
pierres

MB-121 Analogique

VH railcar X-2330 ex-ETAT NÎMES, Red/Cream, cowcatcher (on dit aussi snowplow)
Ex-ETAT X-2330 VH Dieseltriebwagen NÎMES, Rot-Cremweiß, Schienenräumer





BB 67401, Vénissieux, with skirt, number on steel plate, Era III-IV
 BB 67401, Bw Vénissieux, mit Schürze, Nummernschilder, Ep.III-IV

BB-67401

Dépôt de Vénissieux, avec jupes,
 Plaques de numéro, Ep.III-IV
 MB-096 Analogique
 MB-096S : DCC Sound échappement fumée
 MB-096SAC : AC 3 rails échap. fumée



BB 67522, Strasbourg, with skirt, number on steel plate, Era III-IV
 BB 67522, Bw Strasbourg, mit Schürze, Nummernschilder, Ep.III-IV

BB-67522

Dépôt de Strasbourg, avec jupes,
 Plaques de numéro, Ep.III-IV
 MB-097 Analogique
 MB-097S : DCC Sound échappement fumée
 MB-097SAC : AC 3 rails échap. fumée



BB 67534, Caen, without skirt, number on steel plate, Era IV
 BB 67534, Bw Caen, ohne Schürze, Nummernschilder Ep.IV

BB-67534

Dépôt de Caen, sans jupes,
 Plaques de numéro, Ep.IV
 MB-098 Analogique
 MB-098S : DCC Sound échappement fumée
 MB-098SAC : AC 3 rails échap. fumée

BB-67400

Locomotive diesel · Diesel locomotive · Diesellok



BB-67545
 Dépôt de Longueau,
 livrée multi-services, Ep.V
 MB-099 Analogique
 MB-099S : DCC Sound échappement fumée
 MB-099SAC : AC 3 rails échap. fumée



BB 67545, Longueau, Multiservice version Era V
 BB 67545, Bw Longueau, Multiservice Version Ep.V

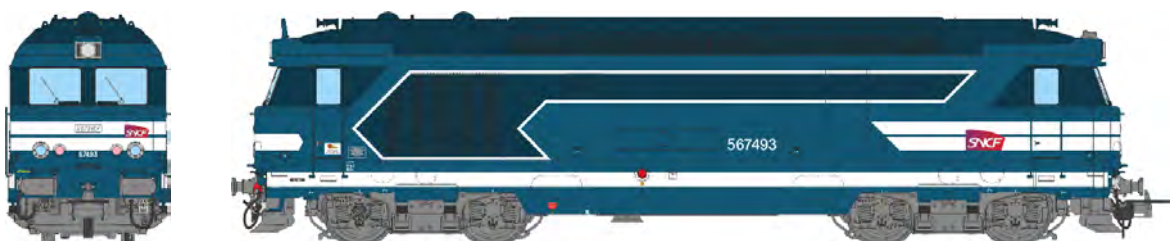

BB-67493 - Dépôt de Marseille, logo Carmillon, Ep.V - MB-100 Analogique - MB-100S : DCC Sound échappement fumée - MB-100SAC : AC 3 rails échap. fumée
 BB 67534, MARSEILLE, Camillon SNCF Logo Era V
 BB 67493, Bw MARSEILLE, Carmillon Anschrift Ep.V



BB-67400
 Locomotive diesel • Diesel locomotive • Diesellok



BB-67047

Dépôt de Nîmes, origine avec plaques «MISTRAL», Ep.III-IV
MB-150 Analogique
MB-150S : DCC Sound échappement fumée
MB-150SAC : AC 3 rails échap. fumée

Diesel locomotive BB 67047 Nîmes railways depot « original condition » with « MISTRAL » train plate Ep.III-IV
BB 67047 Diesellok, NÎMES BW, Originalfassung mit Mistral Schild Ep. III-IV



BB-67381

Dépôt de Caen, persiennes et feux rouges séparés, Ep.IV
MB-151 Analogique
MB-151S : DCC Sound échappement fumée
MB-151SAC : AC 3 rails échap. fumée

Diesel locomotive BB 67381 Caen railways depot Louvers and additional red headlighth Ep. IV
BB 67381 Diesellok, Caen BW, mit Luftschlitzen und separaten roten Ampel, Ep. IV



BB-67382

Dépôt de Tours, moderne logo Casque, Ep.V-VI
MB-152 Analogique
MB-152S : DCC Sound échappement fumée
MB-152SAC : AC 3 rails échap. fumée

Diesel locomotive BB 67382 Tours railways depot, without louver embellishers, SNCF « Casque » SNCF logo Ep.V-VI
BB 67382 Diesellok, Tours BW, Pfeil SNCF Zeichen, Ep. V-VI

BB-67000

Locomotive diesel · Diesel locomotive · Diesellok

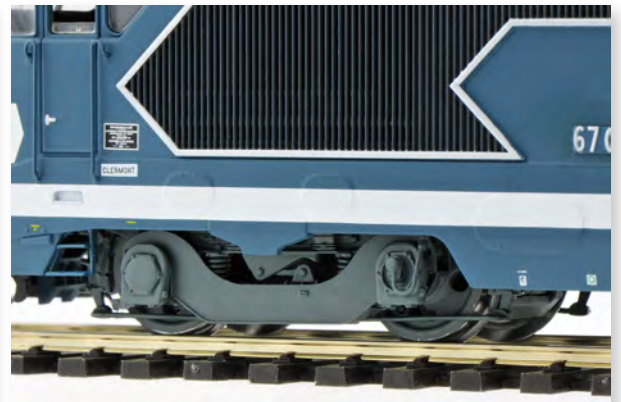



BB-67371

Dépôt de Chambéry, moderne livrée multi-services, Ep.V-VI

MB-153 Analogique

MB-153S : DCC Sound échappement fumée

MB-153SAC : AC 3 rails échap. fumée



Diesel locomotive BB 67371 CHAMBERY railways depot without louver embellishers, Multiservice livery Ep.V-VI
BB 67371 Diesellok, CHAMBERY BW, « Multiservice » Lackierung, Ep. V-VI

BB-67373 - Dépôt de Rennes, moderne, Livrée Isabelle - Ep.V-VI

MB-154 Analogique

MB-154S : DCC Sound échappement fumée

MB-154SAC : AC 3 rails échap. fumée



Diesel locomotive BB 67373 RENNES railways depot without louvers embellisher, Isabelle livery Ep.V-VI
BB 67373 Diesellok, RENNES BW, « Isabelle » blau Lackierung, Ep. V-VI



BB-67000
Locomotive diesel · Diesel locomotive · Diesellok



Collection



Coffret Record du Monde

World record set - Rekord-Set

RECORD MONDIAL DE VITESSE
331 km/h
28 MARS 1955





CC-7107 - Origine, Dépôt Paris Sud Ouest, Ep.III

CM-004 Record du Monde Analogique avec rame de 3 voitures DEV U46 carénées.

CM-004S Record du Monde DCC Sound avec rame de 3 voitures DEV U46 carénées.

CC 7107 ORIGIN Ep. III PARIS SO railways depot - World Record DC Analog with 3 DEV U46 streamlined coaches.

Originalfassung CC 7107 Ep.III PARIS SO BW- Weltrekord - Analog, mit dreiteiliges DEV U46 Personenwagenset.



Coffret Record du Monde
World record set - Rekord-Set

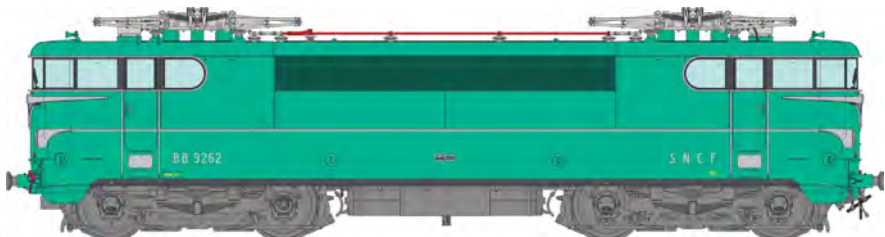

BB-9262 - Origine, Sud-Ouest, Paris Sud-Ouest, Ep.III

MB-080 Analogique - MB-080S : DCC Sound pantographes fonctionnels - MB-080SAC : AC 3 rails pantographes fonctionnels

BB 9262 Origin South-West, PARIS-SO Depot Era III

BB 9262 Originalfassung Elektrolok SUD-OUEST, Paris-SO BW, Ep. III

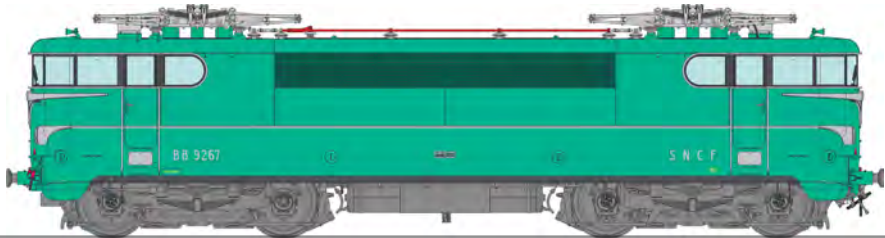

BB-9267 - Origine, Sud-Est Villeneuve, «Mistral», Ep.III

MB-081 Analogique - MB-081S : DCC Sound pantographes fonctionnels - MB-081SAC : AC 3 rails pantographes fonctionnels

BB 9267 Origin South-East, VILLENEUVE « MISTRAL » Era III

BB 9267 Originalfassung Elektrolok SUD-EST, Villeneuve BW, « Mistral », Ep. III



BB-9288 - Rouge Capitole, Sud-Ouest, Paris Sud-Ouest, Ep.III

MB-082 Analogique - MB-082S : DCC Sound pantographes fonctionnels - MB-082SAC : AC 3 rails pantographes fonctionnels

BB 9288 Red CAPITOLE South-West PARIS SO Depot Era III

BB 9288 Rouge CAPITOLE SUD-OUEST Paris-SO Ep.III

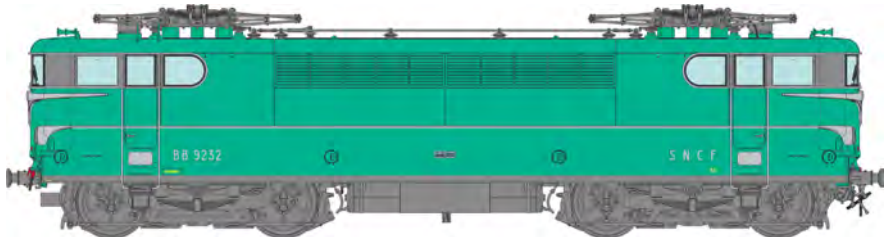

BB-9232 - Enjoliveurs, déjupée, feux rouges séparés, Sud-Est Avignon, Ep.IV

MB-083 Analogique - MB-083S : DCC Sound pantographes fonctionnels - MB-083SAC : AC 3 rails pantographes fonctionnels

BB 9232 without skirt, separate red light, south-west AVIGNON Era IV

BB 9232 Elektrolok mit Aluzierleisten, ohne Schürzen, separate rote ampel, SUD-EST, Avignon BW, Ep. IV



MB-080



Les références *S et *SAC ont des pantographes fonctionnels.
The *S and *SAC references have working pantographs.
Die *S und *SAC ref haben motorisch heb- und senkbare Stromabnehmer.



MB-081



MB-082



MB-083



BB-9200
Locomotive électrique • Electric locomotive • Elektrolok

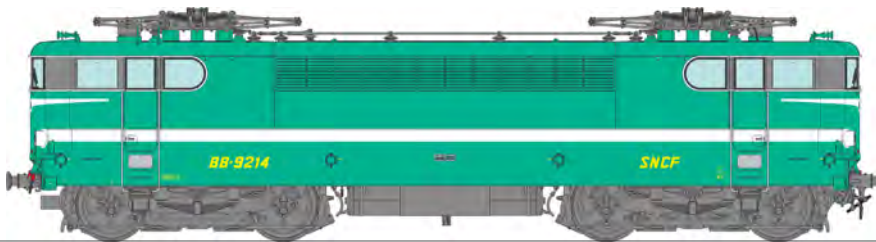

BB-9214 - Livrée «Oullins», vitres demi-lune, grandes persiennes, Bordeaux, Ep.IV - Version INÉDITE en HO
MB-084 Analogique - MB-084S : DCC Sound pantographes fonctionnels - **MB-084SAC : AC 3 rails** pantographes fonctionnels
BB 9214 « Oullins » livery, Half-Moon, large ventilation louver – Bordeaux Ep.IV - Unseen model version: So called « Oullins » livery with Half-Moon following side windows, Low road number with large ventilation louver • BB 9214 Elektrolok, Oullins Lackierung, großen Luftschlitzten – Bordeaux BW, Ep. IV

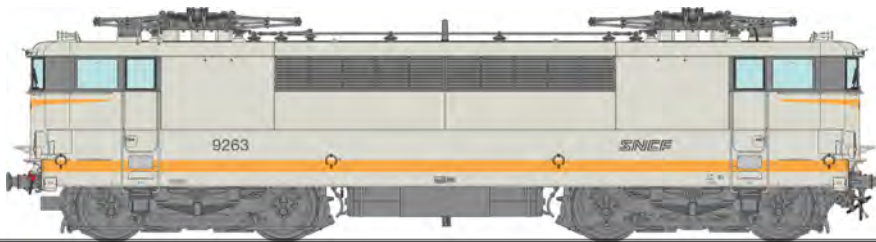

BB-9263 - Livrée béton, Logo Nouille, bande Chamois, Paris Sud-Ouest, Ep.IV-V
MB-085 Analogique - MB-085S : DCC Sound pantographes fonctionnels - **MB-085SAC : AC 3 rails** pantographes fonctionnels
*BB 9263 « Béton » grey livery, « nouille » SNCF logo, SNCF « Chamois » colour strip – Paris-SO Ep.IV/V
 BB 9263 Elektrolok, grau Lackierung, Nudel SNCF Zeichnung, Paris – SO BW, Ep IV-V*

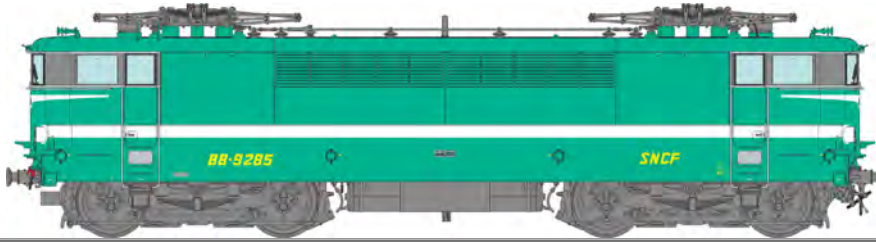

BB-9285 - Livrée «Oullins», Paris Sud-Ouest, Ep.IV-V
MB-086 Analogique - MB-086S : DCC Sound pantographes fonctionnels - **MB-086SAC : AC 3 rails** pantographes fonctionnels
*BB 9285 « Oullins » livery, Paris-SO Ep.IV/V
 BB 9285 Elektrolok, Oullins Lackierung, Paris-SO BW, Ep. IV-V*



BB-9270 - Livrée Béton, sigle casquette, bande Orange TGV, Dijon Perrigny, Ep.V-VI (Machine préservée)
MB-087 Analogique - MB-087S : DCC Sound pantographes fonctionnels - **MB-087SAC : AC 3 rails** pantographes fonctionnels
*BB 9270 « Béton » grey livery, « casquette » SNCF logo, TGV Orange strip – Dijon-Perrigny Ep.V-VI – Preserved locomotive
 BB 9270 Elektrolok, grau Lackierung, Pfeil SNCF Zeichnung, Dijon-Perrigny BW, Ep. V-VI*



Les machines de cette première série n'ont jamais été reproduites en production industrielle. *The locomotives included in this series are used in industrial production. Die Maschinen dieser ersten Serie wurden nie in der industriellen Produktion hergestellt.*

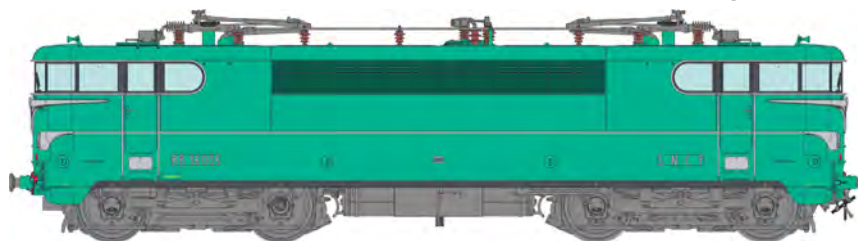

BB-16005 - Origine sortie d'usine, Marchepieds sur bogies, petites rambardes, équipement de freins sous châssis sans capotage, prise de vitesse mécanique le long du bogie, Strasbourg, Ep.III
MB-140 Analogique - **MB-140S** : DCC Sound pantographes fonctionnels - **MB-140SAC** : AC 3 rails pantographes fonctionnels
BB 16005 Original condition brand new, Strasbourg depot EP.III - Steps on bogies / small handrails, no hood on underframe brake gear, Mechanical speed indicator power take off alongside the bogie.
BB 16005 Elektrolok, Originalfassung, Strasbourg BW, Ep. III

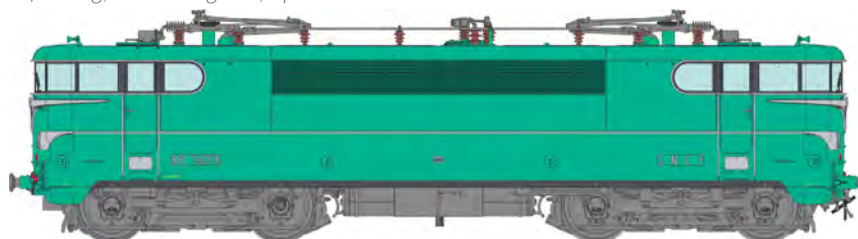

BB-16015 - Origine Sortie d'usine, FLECHE D'OR - Marchepieds sur bogies / petites rambarde, équipement de freins sous châssis sans capotage, prise de vitesse mécanique le long du bogie, La Chapelle Ep.III
MB-141 Analogique - **MB-141S** : DCC Sound pantographes fonctionnels - **MB-141SAC** : AC 3 rails pantographes fonctionnels
BB 16015 Original condition brand new, « FLECHE D'OR » train plate - La Chapelle depot Ep.III - Steps on bogies / small handrails, no hood on underframe brake gear. Mechanical speed indicator power take off alongside the bogie.
BB 16015 Elektrolok, Originalfassung, FLECHE D'OR - La Chapelle BW, Ep. III

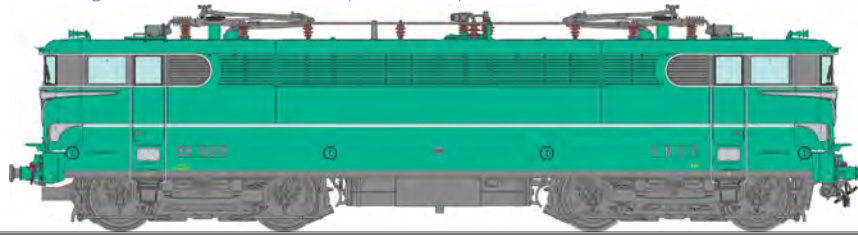

BB-16019 - Verte à enjoliveurs traverses renforcées - La Chapelle, Ep.III - **MB-142 Analogique**
MB-142S : DCC Sound pantographes fonctionnels - **MB-142SAC** : AC 3 rails pantographes fonctionnels
BB 16019 Green with embellishers Reinforced front beam - La Chapelle depot
BB 16019 Elektrolok, grün Lackierung mit Aluzierleisten - La Chapelle BW, Ep. IV-V



BB-16024 - Béton Logo Plein Traverses renforcées, La Chapelle, Ep.III - **MB-143 Analogique**
MB-143S : DCC Sound pantographes fonctionnels - **MB-143SAC** : AC 3 rails pantographes fonctionnels
BB 16024 « Béton » livery downstroke SNCF logo Reinforced front beam - La Chapelle depot
BB 16024 Elektrolok, grau Lackierung - La Chapelle BW, Ep. IV-V



Les modèles DCC Sound sont équipées d'un système fumigène SEUTHE et d'un Power Pack. *The DCC Sound models are fitted with a SEUTHE smoke generator.* Die DCC Sound Lokomotiven sind mit einem SEUTHE Dampfgenerator ausgestattet.



030 TU WD-1405 BRUSSELS

Machine du War Department
MB-041 Analogique
MB-041S : DCC Sound échappement fumée

030 TU WD-1405 BRUSSELS, War Department locomotive
030 TU WD-1405 BRUSSELS, War Department Dampfloek



030 TU OBB 989.03 - AUTRICHE

MB-043 Analogique
MB-043S : DCC Sound échappement fumée

030 TU OBB 989.03 - AUSTRIAN locomotive
ÖBB 030 TU 989.03 - ÖSTERREICH



030 TU 5 EST

Île Napoléon «SOYEZ PRUDENT»

MB-044 Analogique
MB-044S : DCC Sound échappement fumée

030 TU 5 « EST », ILE NAPOLEON railways depot
«SOYEZ PRUDENT»
EST 030 TU 5, ILE NAPOLEON BW, «SOYEZ PRUDENT»
Kennzeichnung



030 TU 27 OUEST

Dépôt de Nantes

MB-045 Analogique
MB-045S : DCC Sound échappement fumée

030 TU 27 « OUEST », NANTES railways depot
OUEST 030 TU 27, NANTES BW



030 TU 56 OUEST

Dépôt de Sotteville, verte filets jaunes

MB-102 Analogique

MB-102S : DCC Sound échappement fumée

*030 TU 56 « OUEST », Sotteville railways depot, Green with yellow fillet
OUEST 030 TU 56, Sotteville BW, grün Lackierung mit gelben Streifen*



030 TU 25 NORD

Dépôt de La Chapelle, noire

MB-103 Analogique

MB-103S : DCC Sound échappement fumée

*030 TU 25 « NORD » La Chapelle railways depot, Black
NORD 030 TU 25, La Chapelle BW, schwarz Lackierung*



030 TU 46 NORD

Machine au GAS-OIL,

Dépôt de Marseille, noire

MB-104 Analogique

MB-104S : DCC Sound échappement fumée

*030 TU 46 GAS-OIL burner,
Marseille railways depot, Black
SNCF 030 TU 46, Heizöl Dampflok,
Marseille BW, schwarz*



030 TU 74 OUEST

Machine au GAS-OIL,

Dépôt d'Annemasse, verte

MB-105 Analogique

MB-105S : DCC Sound échappement fumée

*030 TU 74 GAS-OIL burner,
Annemasse railways depot, Green
SNCF 030 TU 74, Heizöl Dampflok,
Annemasse BW, grün Lackierung*



030 TU JZ 62-067

Machine Yougoslavie

MB-116 Analogique

MB-116S : DCC Sound échappement fumée

*030 TU JZ 62-067 Yugoslavian locomotive
JZ 030 TU 62-067 Dampflok Jugoslawien*



030-TU

Locomotive vapeur · Steam locomotives · Dampflok



4-141 F 309 SNCF Périgueux railways depot – double smoke stack, small smoke deflectors, ACFI water pump, 25m³ 25-A-47 tender, provided with an additional set of Montluçon depot road number plate.
SNCF 4-141 F 309 Périgueux – Doppelschornstein, kleinen Windleitblechen, ACFI Pumpe, 25 m³ 25 A 47 Tender, mit zusätzlichen Montluçon Kennzeichen geliefert.

4-141 F 309 SNCF Périgueux

Cheminée double, petits écrans pare-fumée, pompe ACFI, tender 25m³ 25 A 47, livrée avec un jeu de plaques supplémentaires Montluçon - Ep.III

MB-126 Analogique

MB-126S : DCC Sound échappement fumée

MB-126SAC : AC analogique échap. fumée



4-141 E 425 SNCF Montluçon railways depot – double smoke stack, large smoke deflectors, DABEG water pump, 25m³ 25A593 tender, provided with two additional sets of road number plates (1 Capdenac depot and 1 without depot name)
SNCF 4-141 E 425 Montluçon – Doppelschornstein, großen Windleitblechen, DABEG Pumpe, 25 m³ 25 A 593 Tender, mit Zwei zusätzlichen Capdenac Kennzeichen und ohne Depot Zeichen geliefert.

4-141 E 425 SNCF Montluçon

Cheminée double, grands écrans pare-fumée, pompe DABEG, tender 25 m³ 25 A 593, livrée avec deux jeux de plaques supplémentaires Capdenac et sans cartouche de nom de dépôt - Ep.III

MB-127 Analogique

MB-127S : DCC Sound échappement fumée

MB-127SAC : AC analogique échap. fumée



5-141 E 234 SNCF Grenoble railways depot – double smoke stack, small smoke deflectors, ACFI water pump, 25 m³ 25 A 11 tender.
SNCF 5-141 E 234 Grenoble – Doppelschornstein, kleinen Windleitblechen, ACFI Pumpe, 25 m³ 25 A 11 Tender.

5-141 E 234 SNCF Grenoble

Cheminée double, petits écrans pare-fumée, pompe ACFI, tender 25 m³ 25 A 11 - Ep.III

MB-128 Analogique

MB-128S : DCC Sound échappement fumée

MB-128SAC : AC analogique échap. fumée





6-141 E 458 SNCF Veynes

Cheminée double, grands écrans
pare-fumée, pompe DABEG,
tender 25 m³ 25 A 88 - Ep.III

MB-129 Analogique

MB-129S : DCC Sound échappement fumée

MB-129SAC : AC analogique échap. fumée



6-141 E 458 SNCF Veynes railways depot - double smokestack, large smoke deflectors, DABEG water pump, 25m³ 25A88 tender
SNCF 6-141 E 458 Veynes - Doppelschornstein, großen Windleitblechen, DABEG Pumpe, 25 m³ 25 A 88 Tender

5-141 E 284 SNCF Villeneuve

Cheminée double, grands écrans
pare-fumée, pompe ACFI,
tender 25 m³ 25 A 27 - Ep.III

MB-130 Analogique

MB-130S : DCC Sound échappement fumée

MB-130SAC : AC analogique échap. fumée



5-141 E 284 SNCF Villeneuve railways depot - double smokestack, large smoke deflectors, ACFI water pump, 25 m³ 25 A 27 tender
SNCF 5-141 E 284 Villeneuve - Doppelschornstein, großen Windleitblechen, ACFI Pumpe, 25 m³ 25 A 27 Tender

4-141 F 282 SNCF Montluçon

Cheminée double, petits écrans
pare-fumée, pompe ACFI, tender 25 m³ 25 A 44, Machine
préservée à la Cité du
Train de Mulhouse - Ep.III

MB-131 Analogique

MB-131S : DCC Sound échappement fumée

MB-131SAC : AC analogique échap. fumée



4-141 F 282 SNCF Montluçon railways depot - double smoke stack, small smoke deflectors, ACFI water pump, 25 m³ 25 A 44 tender, preserved in « La Cité du Train » Mulhouse museum.
SNCF 4-141 F 282 Montluçon - Doppelschornstein, kleinen Windleitblechen, ACFI Pumpe, 25 m³ 25 A 44 Tender. Diese Lokomotive ist im Mulhouse Cité du Train Museum ausgestellt.

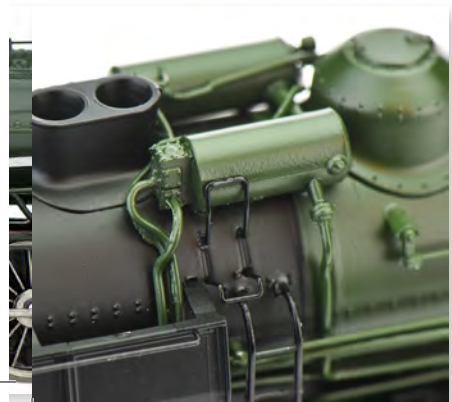

141E/F
Locomotive vapeur · Steam locomotives · Dampflok



2-231 K 4 Boulogne - Cheminée double, grands écrans pare-fumée, pompe Bi-Compound, ACFI, tender 38m³, machine et tender Vert, filets rouges - Ep.III

MB-132 Analogique - MB-132S : DCC Sound échappement fumée - **MB-132SAC : AC analogique** échap. fumée

2-231 K 4 Boulogne railways depot- double smoke stack, large smoke deflectors, Bi-Compound air pump, ACFI preheating, 38m³ tender, Green locomotive and tender, red fillets Era III

SNCF 2-231 K 4 Boulogne - Doppelschornstein, großen Windleitblechen, Bi-compound Pumpe, ACFI, 38 m³ Tender, grün Lackierung mit roten Streifen Ep.III



2-231 G 131 SNCF Calais - Cheminée double, grands écrans pare-fumée, pompe Bi-Compound, ACFI, tender 38m³, Vert SNCF filets rouges - Ep.III

MB-133 Analogique - MB-133S : DCC Sound échappement fumée - **MB-133SAC : AC analogique** échap. fumée

2-231 G 131 Calais railways depot - double smoke stack, large smoke deflectors, Bi-Compound air pump, ACFI preheating, 38m³ tender, SNCF Green, red fillets Era III

SNCF 2-231 G 131 Calais - Doppelschornstein, großen Windleitblechen, Bi-compound Pumpe, ACFI, 38 m³ Tender, grün Lackierung mit roten Streifen Ep.III





REE
MODELES



231 D 154 PLM - Cheminée simple, sans écrans pare-fumée, pompe Fives-Lille, ACFI, tender 30m³ avec rehausse en planches, vert PLM filets rouges - Ep.III
MB-134 Analogique - MB-134S : DCC Sound échappement fumée - **MB-134SAC : AC analogique** échap. fumée

2-231 D 154 PLM - simple smoke stack, without smoke deflectors, Fives-Lille air pump, ACFI preheating, 30m³ tender with planks made coal bunker extension, PLM Green, red fillets PLM Era II
PLM 231 D 154 - Ohne Windleitblechen, Fives-Lille Pumpe, ACFI, 30 m³ Tender mit Holzaufsatzwände, PLM grün Lackierung mit roten Streifen Ep.II



1-231 G 236 SNCF Reims - Cheminée double, grands écrans pare-fumée, pompe Bi-Compound, ACFI, tender 30m³, Noire SNCF, filets rouges - Ep.III
MB-135 Analogique - MB-135S : DCC Sound échappement fumée - **MB-135SAC : AC analogique** échap. fumée

1-231 G 236 SNCF Reims railways depot - double smoke stack, large smoke deflectors, Bi-Compound air pump, ACFI preheating, 30m³ tender, SNCF Black, red fillets Era III
SNCF 1-231 G 236 Reims - Doppelschornstein, großen Windleitblechen, Bi-compound Pumpe, ACFI, 30 m³ Tender, schwarz Lackierung mit roten Streifen Ep.III

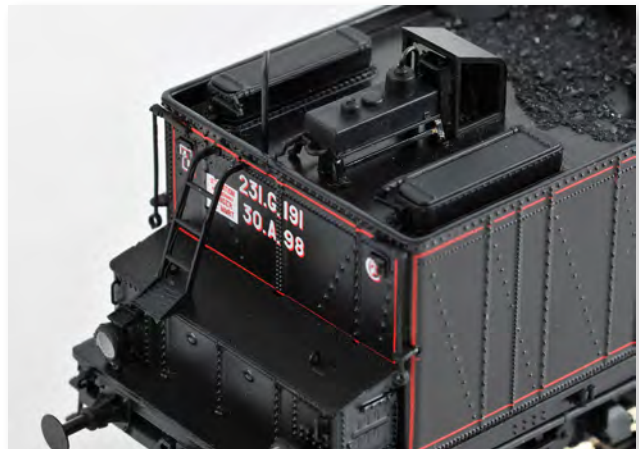

PHOTO D.BURAUD

231 ex-PLM
Locomotive vapeur · Steam locomotives · Dampfloek



2-231 K 44 Calais - Cheminée double, grands écrans pare-fumée, pompe Bi-Compound, ACFI, tender 38m³, machine et tender Vert, filets jaunes - Ep.III

MB-136 Analogique - MB-136S : DCC Sound échappement fumée - **MB-136SAC : AC analogique** échap. fumée

2-231 K 44 Calais railways depot - double smoke stack, large smoke deflectors, Bi-Compound air pump, ACFI preheating, 38m³ tender, Green locomotive and tender, yellow fillets.

SNCF 2-231 K 44 Calais - Doppelschornstein, großen Windleitblechen, Bi-compound Pumpe, ACFI, 38 m³ Tender, grün Lackierung mit gelben Streifen Ep.III



5-231 E 46 SNCF Montargis - cheminée simple, petits écrans pare-fumée, pompe Fives-Lille, ACFI, tender 25m³, Vert SNCF Ep.III

MB-137 Analogique - MB-137S : DCC Sound échappement fumée - **MB-137SAC : AC analogique** échap. fumée

5-231 E 46 SNCF Montargis railways depot - simple smoke stack, smoke deflectors, Fives-Lille air pump, ACFI preheating, 25m³ tender, SNCF green.

SNCF 5-231 E 46 Montargis - Kleinen Windleitblechen, Fives-Lille Pumpe, ACFI, 25 m³ Tender, grün Lackierung Ep.III



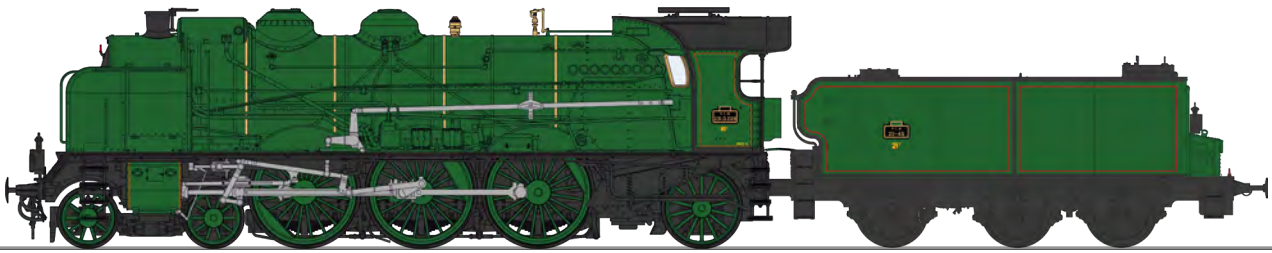

231 D 229 PLM - Cheminée simple, sans écrans pare-fumée, pompe Fives-Lille, ACFI, tender 25m³, Vert PLM filets rouges, Ep.III
MB-138 Analogique - MB-138S : DCC Sound échappement fumée - **MB-138SAC : AC analogique** échap. fumée
2-231 D 229 PLM - simple smoke stack, without smoke deflectors, Fives-Lille air pump, ACFI preheating, 25m³ tender, PLM Green, red fillets.
PLM 231 D 229 - Ohne Windleitblechen, Fives-Lille Pumpe, ACFI, 25 m³ Tender, PLM grün Lackierung mit roten Streifen Ep.III

231 ex-PLM
Locomotive vapeur · Steam locomotives · Dampflok

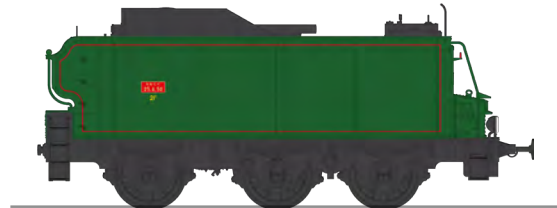

Tender 25 m³ 25 A 50 SNCF - TIA, Vert SNCF, filets rouges, Ep. III (pour décor uniquement)
MB-139
25 m³ Tender 25 A 50 SNCF, TIA, SNCF green red fillets (only for scenery purpose) Era III
SNCF 25 m³ 25 A 50 Tender, TIA, SNCF Grün Lackierung, mit roten Streifen (Standmodel) Ep.III





Toutes les machines réf. MBE-005 à MBE-008 sont avec décodeur sonorisé et fumée pulsée. Elles sont compatibles 2 rails et 3 rails Märklin. Elles possèdent un attelage fonctionnel

All the ref. MB-005 to MB-008 models are fitted with a DCC Sound decoder and forced smoke gear. The models can run on both 2 rails DC system and Märklin 3 rail system. They are fitted with working coupler.

Alle MB-005 bis MB-008 Dampfloks sind mit Sounddecoder, Pulsrauch und digitalen Magnetkupplungen ausgestattet.

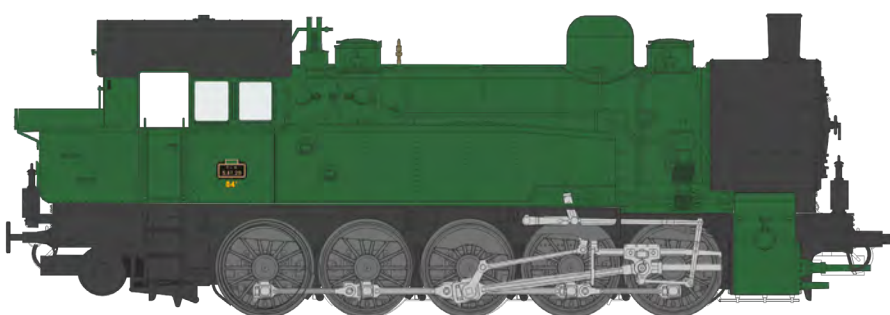
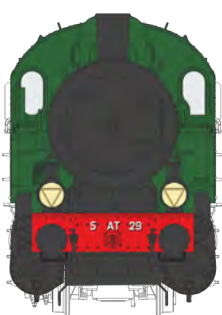

PLM 5 AT 29 - Epoque II - MBE-005

PLM 5 AT 29 Ex-German T16.1 Ep.II
PLM Ex-T16.1 5 AT 29 Ep.II

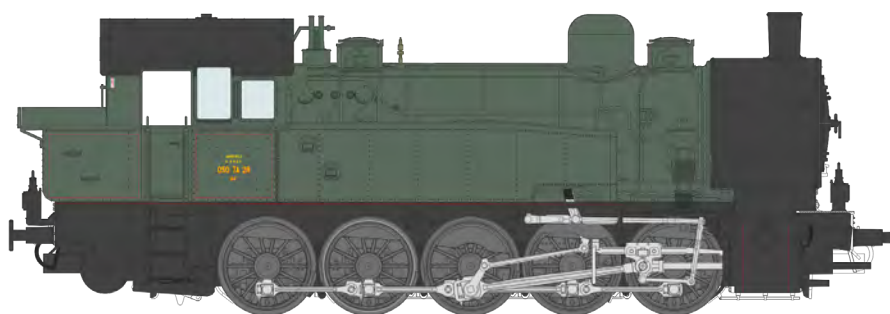

SNCF 050 TA 28 - Sud-Est, Dépôt Ambérieu, Ep. III - MBE-006

SNCF 050 TA 28 «Sud-Est» Ex-German T16.1 Ambérieu depot Ep.III
SNCF Ex-T16.1 050 TA 28 «Sud-Est» Ambérieu DW Ep.III

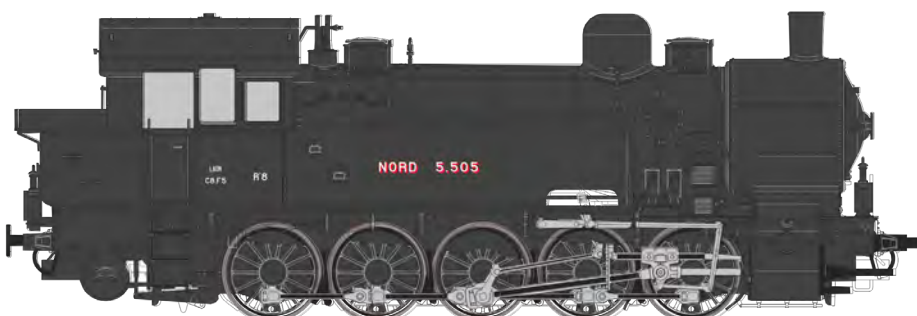
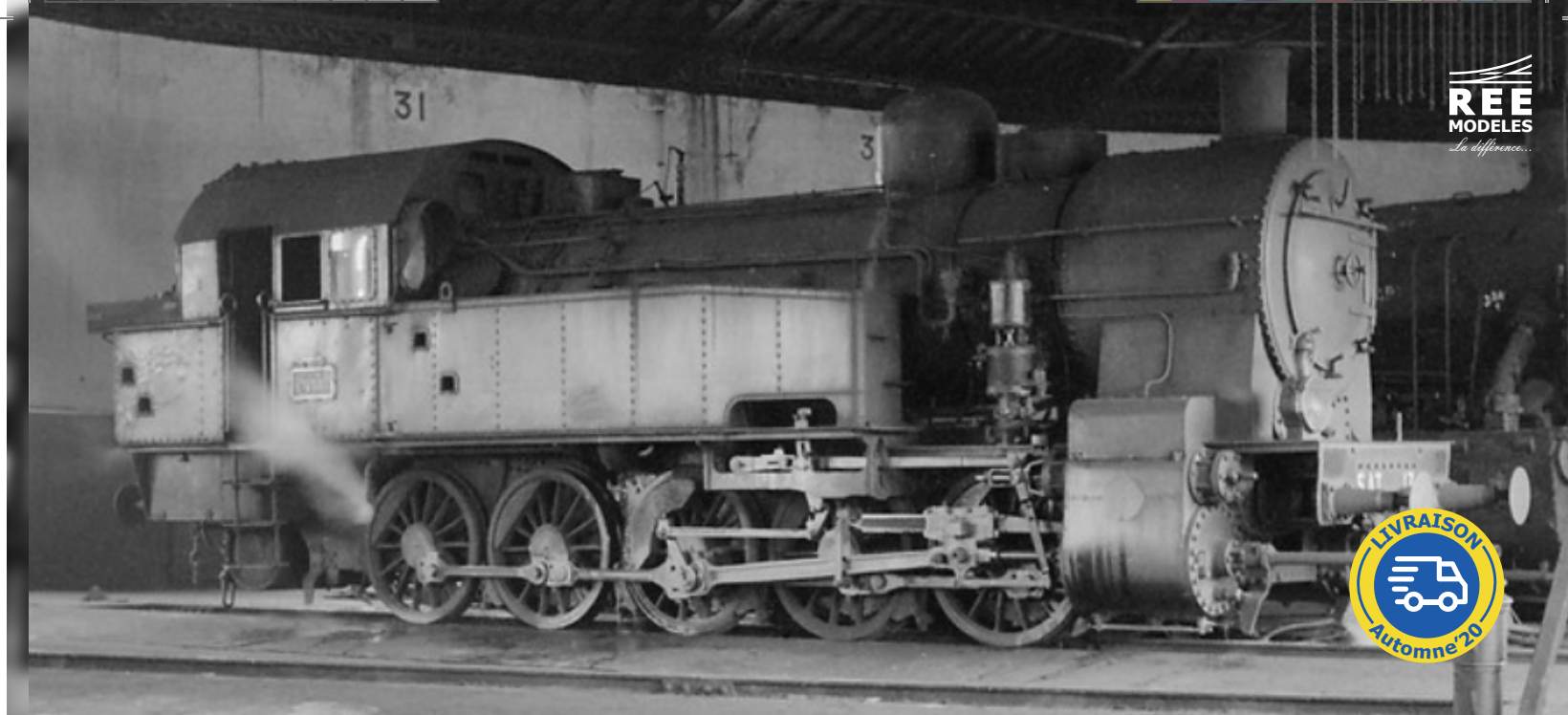

NORD 5.505 - Epoque II - MBE-007
NORD 5.505 Ex-German T16.1 Ep.II
Nord Ex-T16.1 5.505 Ep.II

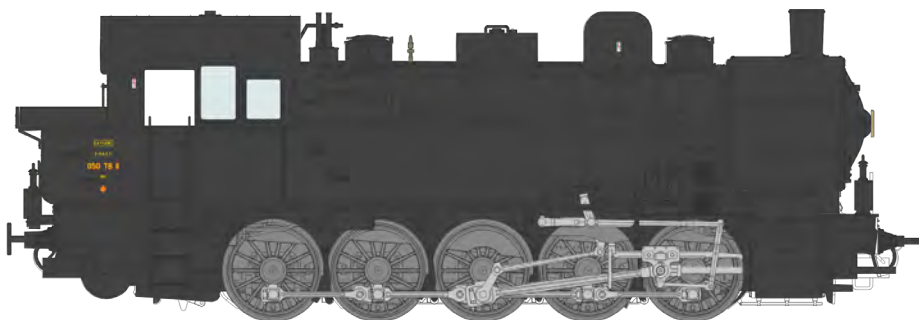

SNCF 050 TB 11 - Nord, Dépôt de La Plaine, Ep. III - MBE-008
SNCF 050 TB 11 Ex-German T16.1 « NORD » La Plaine depot Ep.III
SNCF Ex-T16.1 050 TB 11 NORD dépôt de La Plaine Ep.III



Ex-T16.1 Allemande
 Locomotive vapeur · Steam locomotives · Dampfloek



LIVRAISON
Automne '20



Grey riveted roof, P.O. lookout box, pillow block bearings, Fenced windows N°Dq25622 Era II - PO - VB-108S - DCC Opening doors with decoder
Dach genietet grau, PO Dachkanzel, Gleitachslager, Fenstergitter, N°Dq25622 Ep.II - PO - VB-108S - DCC Schiebetür zum Öffnen mit Decoder

VB-108 P.O., toit riveté, Vigie PO, boîtes à coussinets, PO Grilles aux fenêtres - Ep. II
VB-108S avec décodeur intégré et deux portes ouvrantes par servo-moteur.



Black riveted roof, P.O. lookout box, pillow block bearings, Fenced windows Ex-P.O. "Toulouse" N°49523 Era III
Dach genietet schwarz, PO Dachkanzel, Gleitachslager, «Toulouse» Ehem. PO Fenstergitter, N°49523 Ep.III

VB-109 Toit riveté et bouts noirs, Vigie PO, boîtes à coussinets, ex-PO Toulouse Grilles aux fenêtres - Ep. III
VB-109S avec décodeur intégré et deux portes ouvrantes par servo-moteur.

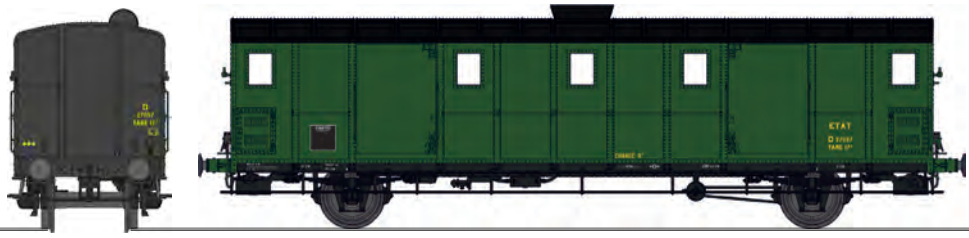

Black riveted roof, ETAT lookout box, pillow block bearings, metal bars on windows N°27097 Era II - ETAT
Dach genietet schwarz, ETAT Dachkanzel, Gleitachslager, Fenstergitter, N°27097 Ep.II - ETAT

VB-110 ÉTAT Toit riveté, Vigie Etat, boîtes à coussinets, Barres aux fenêtres - Ep. II
VB-110S avec décodeur intégré et deux portes ouvrantes par servo-moteur.



Black riveted roof, ETAT lookout box, pillow block bearings, metal bars on windows Ex-ETAT « Batignolles » N°39834 Era III
Dach genietet schwarz, ETAT Dachkanzel, Gleitachslager, «Batignolles» Ehem. ETAT, Fenstergitter, N°39834 Ep.III

VB-111 Toit riveté, Vigie Etat, boîtes à coussinets, Ex-ETAT Batignolles Barres aux fenêtres - Ep. III
VB-111S avec décodeur intégré et deux portes ouvrantes par servo-moteur.



Green riveted roof and ends, 2 small headlights, pillow block bearings «Batignolles» Ex-ETAT metal bars on windows N°39847 Era III
Dach genietet und Stirnwand grün, 2 kleine Schlusslichter 1 rechts, Gleitachslager, «Batignolles» Ehem. ETAT, Fenstergitter, N°39847 Ep.III

VB-112 Feux de fin convoi fonctionnels (3 feux dont 1 à droite), toit riveté noir, boîtes à coussinets, Ex-Etat Batignolles Barres vitres - Ep. III
VB-112S avec décodeur intégré, feux fonctionnels des deux côtés et deux portes ouvrantes par servo-moteur.

Fourgon OCEM 29
OCEM luggage Van · OCEM Gepäckwagen



VB-113 Toit riveté et bouts noirs, 2 petits feux et 1 à droite, boîtes à coussinets, «Sotteville» Ex-ETAT Barres aux fenêtres N°39824 feux de fin de convoi - Ep.III
VB-113S Feux de fin de convoi et portes ouvrantes avec décodeur.



*Black riveted roof and ends, 2 small headlights, pillow block bearings, «Sotteville» Ex- ETAT metal bars on windows N°39824 Ep.III
Dach genietet und Stirnwand schwarz, 2 kleine Schlusslichter 1 rechts, Gleitachslager, «Sotteville» Ehem. ETAT, Fenstergitter, N°39824 Ep.III*

VB-114 Toit riveté et bouts noirs, 2 Petits Feux et 1 central, boîtes à coussinets, «Limoges» Ex-PO Grilles aux fenêtres N°49842 feux de fin de convoi - Ep.III
VB-114S Feux de fin de convoi et portes ouvrantes avec décodeur.



*Black riveted roof and ends, 2 small headlights and 1 centered, pillow block bearings, «Limoges» Ex-PO Fenced windows N°49842 Era III
Dach genietet und Stirnwand schwarz, 2 kleine Schlusslichter und 1 mittig, Gleitachslager, «Limoges» Ehem. PO, Fenstergitter, N°49842 Ep.III*

VB-115 Toit lisse, 2 feux, boîtes à rouleaux, «Bordeaux» Ex-ETAT Barres aux fenêtres, logo jaune N°50 87 93 57 288-6 feux de fin de convoi - Ep.IV-V
VB-115S Feux de fin de convoi et portes ouvrantes avec décodeur.



*Smooth roof, 2 headlights, roller bearings, «Bordeaux» ex-ETAT metal bars on windows, Yellow SNCF logo N°50 87 93 57 288-6 Era IV-V
Flachdach, 2 Schlusslichter, Rollenachslager, «Bordeaux» Ehem. ETAT, Fenstergitter, Gelbes Logo, N°50 87 93 57 288-6 Ep.IV-V*

VB-116 - Toit lisse, 2 feux, boîtes à rouleaux, «Villeneuve» ex-PO Grilles aux fenêtres, logo blanc N°80 87 961 0 219-8 feux de fin de convoi - Ep.IV-V
VB-116S Feux de fin de convoi et portes ouvrantes avec décodeur.

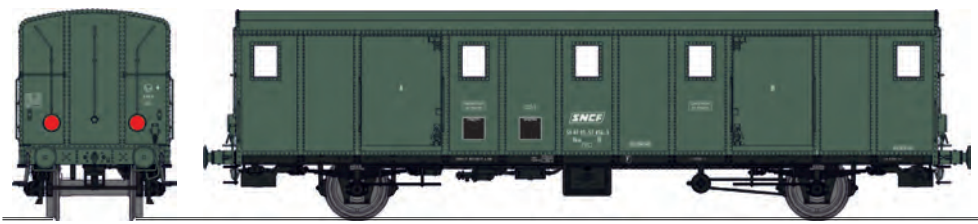

*Smooth roof, 2 headlights, roller bearings, «Villeneuve» Ex-PO Fenced windows, White SNCF logo N°80 87 961 0 219-8 Era IV-V
Flachdach, 2 Schlusslichter, Rollenachslager, «Villeneuve» Ehem. PO, Fenstergitter, Weißes Logo, N°80 87 961 0 219-8 Ep.IV-V*

VB-117 - Toit lisse, 2 feux, boîtes à rouleaux, N°80 87 961 0 219-8 feux de fin de convoi - Ep.IV-V
VB-117S Feux de fin de convoi et portes ouvrantes avec décodeur.



*Smooth roof, 2 headlights, roller bearings, V N°80 87 961 0 219-8 Era IV-V
Flachdach, 2 Schlusslichter, Rollenachslager, V N°80 87 961 0 219-8 Ep.IV-V*

Fourgon OCCEM 32
OCCEM Luggage Van - OCCEM Gepäckwagen



Fourgon OCEM 32

OCEM luggage Van · OCEM Gepäckwagen



VB-310 Toit et bouts noirs,
3 feux Région EST SNCF
N°26503 Ep.III A

*Black roof and ends, 3 headligths East
SNCF N°26503 Era III A*

*Dach und Stirnwand schwarz, 3 Schluss-
lichter, Region Ost, SNCF N°26503 Ep.III A*



VB-311 Toit et bouts noirs,
3 feux Région OUEST SNCF
N°27534 Ep.III A

*Black roof and ends, 3 headligths West SNCF
N°27534 Era III A*

*Dach und Stirnwand schwarz, 3 Schlusslich-
ter, Region West, SNCF N°27534 Ep.III A*

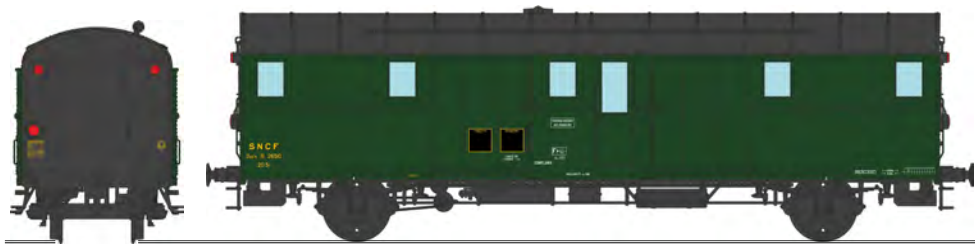

VB-312 Toit et bouts noirs,
3 feux, Région SUD-EST SNCF
N°26510 Ep.III A

*Black roof and ends, 3 headligths South-
East REGION SNCF N°26510 Era III A*

*Dach und Stirnwand schwarz, 3 Schluss-
lichter, Region Süd-Ost, SNCF N°26510
Ep.III A*

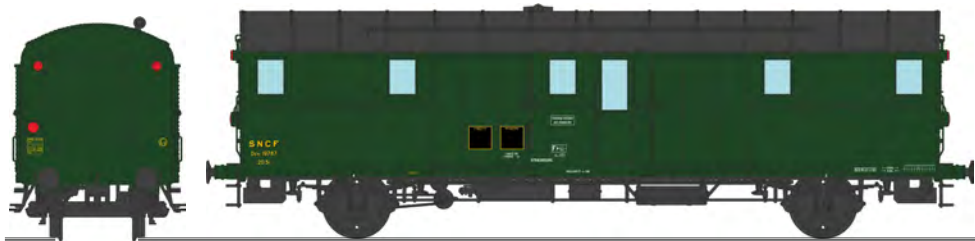

VB-313 Toit noir, bouts verts,
3 feux Région EST SNCF
N°19787 Ep.III B

*Black roof, green ends, 3 headligths East
SNCF N°19787 Era III B*

*Dach schwarz, Stirnwand grün, 3 Schluss-
lichter, Region Ost, N°19787 Ep.III B*



VB-314 Toit noir, bouts verts,
3 feux Région SUD-OUEST SNCF
N°49808 Ep.III B

*Black roof, green ends, 3 headligths South-
West SNCF N°49808 Era III B*

*Dach schwarz, Stirnwand grün, 3 Schluss-
lichter, Region Süd-West, SNCF N°49808
Ep.III B*



VB-315 vert 306,
3 feux, Région EST SNCF
N°19948 Ep.III B

*SNCF green 306, 3 headlighth, East SNCF
N°19948 Era III B*

*Grün, 3 Schlusslichter, Region Ost, SNCF
N°19948 Ep.III B*

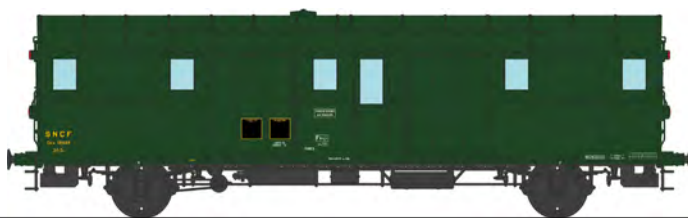

VB-316 vert 306,
3 feux, Région SUD-EST SNCF
N°58689 Ep.III B

*SNCF green 306, 3 headlighth, South-East
REGION SNCF N°58689 Era III B*

*grün, 3 Schlusslichter, Region Süd-Ost,
SNCF N°58689 Ep.III B*

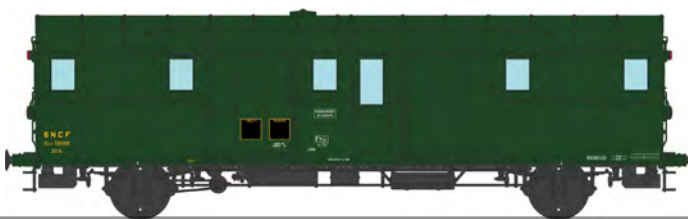

VB-317 vert 306,
3 feux, Région OUEST SNCF
N°39943 Ep.III B

*SNCF green 306, 3 headlighth, West SNCF
N°39943 Era III B*

*grün, 3 Schlusslichter, Region Süd-West,
SNCF N°39943 Ep.III B*

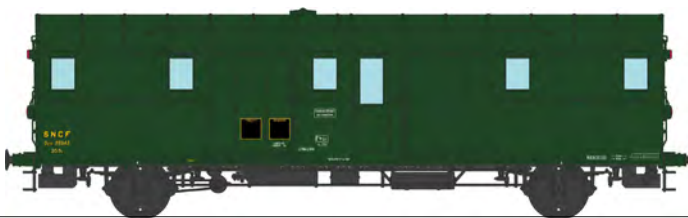

VB-318 vert 306,
3 feux, Région SUD-OUEST SNCF
N°49816 Ep.III B

*vert 306, 3 feux REGION SUD-OUEST
SNCF N°49816 Ep.III B*

*SNCF green 306, 3 headlighth, South-West
SNCF N°49816 Era III B*

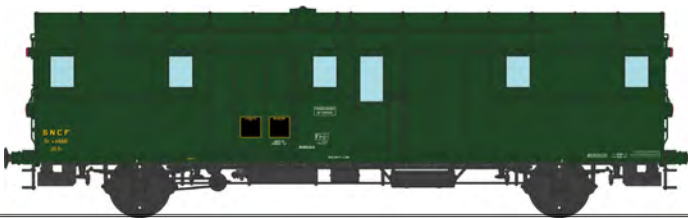

VB-319 vert 301,
3 feux, Région SUD-EST SNCF
N°50 87 93-20 135-3 Ep.IV

*SNCF green 301, 3 headlighth, South-East
SNCF N°50 87 93-20 135-3 Era IV*

*Grün, 3 Schlusslichter, Region Süd-Ost,
SNCF N°50 87 93-20 135-3 Ep.IV*



VB-320 vert 301,
3 feux, Région SUD-EST SNCF
N°50 87 93-20 132-0 Ep.IV

*SNCF green 301, 3 headlighth, East SNCF
N°50 87 93-20 132-0 Era IV*

*grün, 3 Schlusslichter, Region Süd-Ost,
SNCF N°50 87 93-20 132-0 Ep.IV*



VB-321 vert 301,
3 feux Région OUEST SNCF
N°50 87 93-20 113-0 Ep.IV

*SNCF green 301, 3 headlighth, West SNCF
N°50 87 93-20 113-0 Era IV*

*grün, 3 Schlusslichter, Region West, SNCF
N°50 87 93-20 113-0 Ep.IV*



VB-322 vert 301,
3 feux, Région OUEST SNCF
N°50 87 93-20 067-8 Ep.IV

*SNCF green 301, 3 headlighth, West SNCF
N°50 87 93-20 067-8 Era IV*

*grün, 3 Schlusslichter, Region West, SNCF
N°50 87 93-20 067-8 Ep.IV*

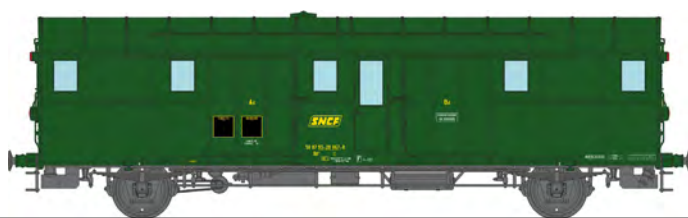



Fourgon OCEM 32

OCEM luggage Van · OCEM Gepäckwagen

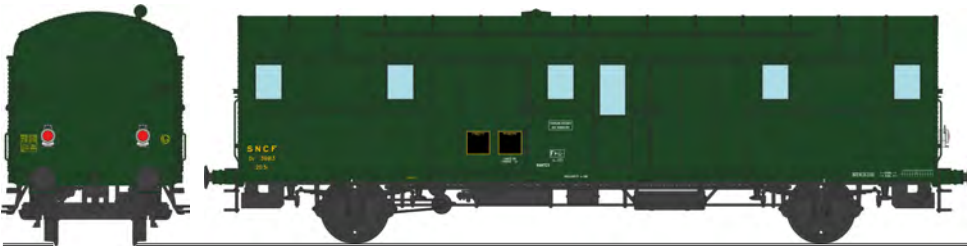

VB-323 Vert 306, 2 lanternes ALU
Région OUEST SNCF
N°39913 Ep.III-IV

SNCF 306 green, 2 Aluminium made lanterns West SNCF N°39913 Era III-IV

grün, 2 Aluschlusslichter, Region West, SNCF N°39913 Ep.III-IV

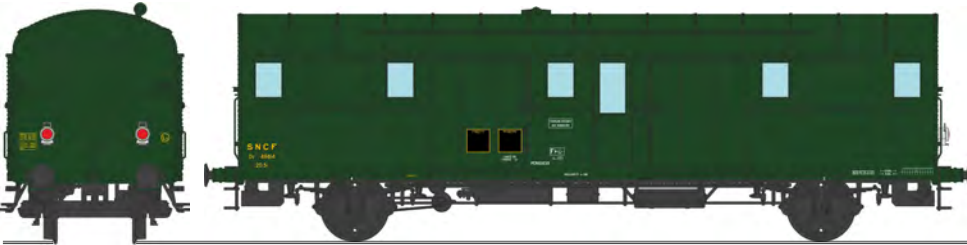

VB-324 Vert 306, 2 lanternes ALU
Région SUD-OUEST SNCF
N° 49814 Ep.III-IV

SNCF 306 green, 2 Aluminium made lanterns South-West SNCF N° 49814 Era III-IV

grün, 2 Aluschlusslichter, Region Süd-West, SNCF N° 49814 Ep.III-IV

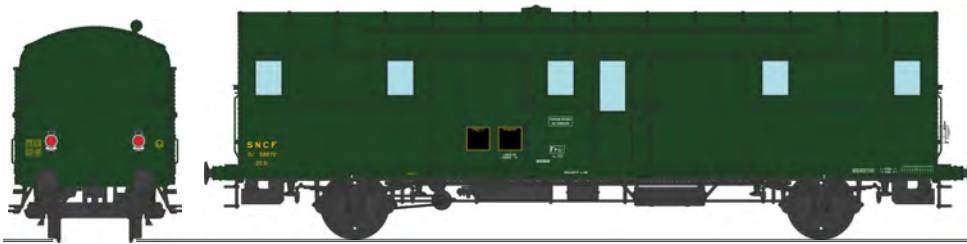

VB-325 Vert 306, 2 lanternes ALU
Région SUD-EST SNCF
N° 58670 Ep.III-IV

SNCF 306 green, 2 Aluminium made lanterns East SNCF N° 58670 Era III-IV

grün, 2 Aluschlusslichter, Region Süd-Ost, SNCF N° 58670 Ep.III-IV



VB-326 Vert 306, sans feux
Région EST SNCF
N°19903 Ep.III-IV

SNCF 306 green, without headlight, East SNCF N°19903 Era III-IV

grün, ohne Schlusslichter, Region Ost, SNCF N°19903 Ep.III-IV

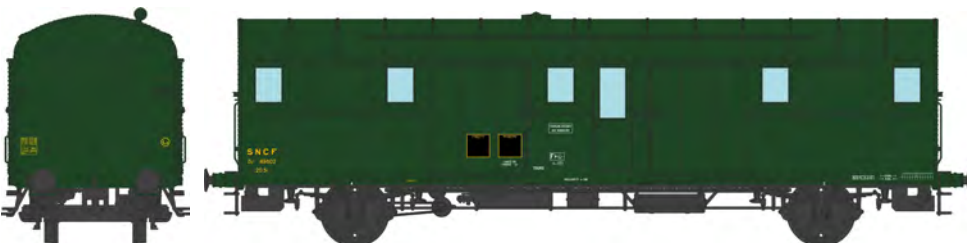

VB-327 Vert 306, sans feux
Région SUD-OUEST SNCF
N°49802 Ep.III-IV

SNCF 306 green, without headlight, South-West SNCF N°49802 Era III-IV

grün, ohne Schlusslichter, Region Süd-West, SNCF N°49802 Ep.III-IV



VB-328 Vert 306, sans feux
Région SUD-EST SNCF
N°58678 Ep.III-IV

*SNCF 306 green, without headlight,
South-East SNCF N°58678 Era III-IV*

*grün, ohne Schlusslichter, Region Süd-Ost,
SNCF N°58678 Ep.III-IV*

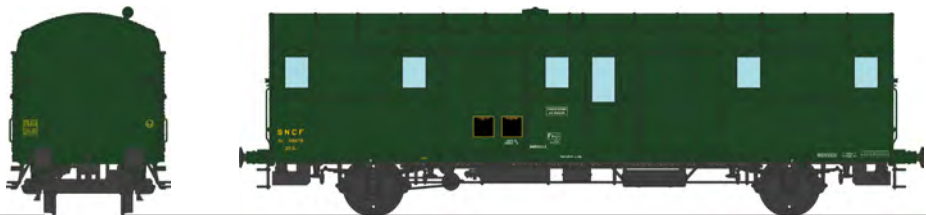

VB-329 Vert 306 2 lanternes ALU,
câblot 1.500 V Région EST SNCF
N°19807 Ep.III-IV

*SNCF 306 green, 2 Aluminium lanterns,
1500V cable East SNCF N°19807 Era III-IV*

*grün, 2 Aluschlusslichter, 1500V Kabel,
Region Ost, SNCF N°19807 Ep.III-IV*



VB-330 Vert 306 2 lanternes ALU,
câblot 1.500 V Région SUD-EST SNCF
N°58691 Ep.III-IV

*SNCF 306 green, 2 Aluminium lanterns, 1500V
cable South-East SNCF N°58691 Era III-IV*

*grün, 2 Aluschlusslichter, 1500V Kabel,
Region Süd-Ost, SNCF N°58691 Ep.III-IV*



VB-331 Vert 301 2 lanternes ALU,
câblot 1.500 V Région EST SNCF
N°50 87 93-17 595-3 Ep.IV

*SNCF 301 green, 2 Aluminium lanterns, 1500V
cable East SNCF N°50 87 93-17 595-3 Era IV*

*grün, 2 Aluschlusslichter, Region Ost, SNCF
N°50 87 93-17 595-3 Ep.IV*



VB-332 Vert 301 2 lanternes ALU,
câblot 1.500 V
Région SUD-OUEST SNCF
N°50 87 93-17 010-3 Ep.IV

*SNCF 301 green, 2 alu. lanterns, 1500V cable
South-West SNCF N°50 87 93-17 010-3 Era IV*

*grün, 2 Aluschlusslichter, Region Süd-West,
SNCF N°50 87 93-17 010-3 Ep.IV*

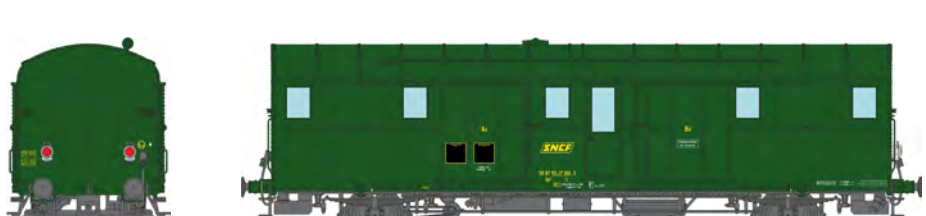

VB-333 Vert 301 sans feux, câblot
1.500 V Région SUD-EST SNCF
N°50 87 93-17 032-7 Ep.IV

*SNCF 301 green, without headlight, 1500V cable
South-East SNCF N°50 87 93-17 032-7 Era IV*

*grün, ohne Schlusslichter, 1500V Kabel, Region
Süd-Ost, SNCF N°50 87 93-17 032-7 Ep.IV*



VB-334 Vert 301 sans feux, câblot
1.500 V Région SUD-OUEST SNCF
N°50 87 93-17 019-4 Ep.IV

*SNCF 301 green, without headlight, 1500V cable
South-West SNCF N°50 87 93-17 019-4 Era IV*

*grün, ohne Schlusslichter, 1500V Kabel, Region
Süd-West, SNCF N°50 87 93-17 019-4 Ep.IV*

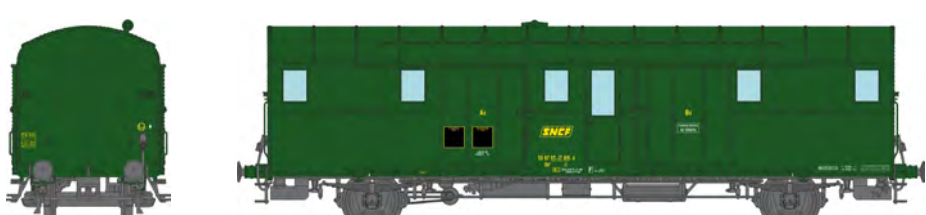



VB-335 vert 306, toit et bouts noirs, porte lanterne ancien, 3 feux, SUD-EST SNCF N°58507 Ep.III
SNCF 306 green, black roof and ends, ancient lantern holders, 3 headlights, South-East SNCF N°58507 Era III

Grün, Dach und Stirnwand schwarz, Signalhalter Alt, 3 Schlusslichter, Süd-Ost, SNCF N°58507 Ep.III



VB-336 vert 306, toit et bouts noirs, porte lanterne ancien, 3 feux, SUD-EST SNCF N°58513 Ep.III

SNCF 306 green, black roof and ends, ancient lantern holders, 3 headlights, South-East SNCF N°58513 Era III

Grün, Dach und Stirnwand schwarz, Signalhalter Alt, 3 Schlusslichter, Region Süd-Ost, SNCF N°58513 Ep.III



VB-337 toit noir, bouts vert 306, porte lanterne ancien, 3 feux, SUD-EST SNCF N°58539 Ep.III

Black roof, SNCF 306 green ends, ancient lantern holders, 3 headlights, South-East SNCF N°58539 Era III

Grün, Dach schwarz, Signalhalter Alt, 3 Schlusslichter, Region Süd-Ost, SNCF N°58539 Ep.III



VB-338 vert 306, porte lanterne ancien, 3 feux, SUD-OUEST SNCF N°49236 Ep.III

SNCF 306 green, ancient lantern holders, 3 headlights, South-West SNCF N°49236 Era III

Grün, Signalhalter Alt, 3 Schlusslichter, Region Süd-West, SNCF N°49236 Ep.III



VB-339 toit noir, bouts verts 306, porte lanterne moderne, 3 feux, SUD-EST SNCF N°58542 Ep.III

Black roof, SNCF 306 green ends, modern lantern holders, 3 headlights, South-East SNCF N°58542 Era III

Grün, Dach schwarz, Signalhalter Neu, 3 Schlusslichter, Süd-Ost, SNCF N°58542 Ep.III



VB-340 toit noir, bouts verts 306,
porte lanterne moderne, 3 feux
SUD-OUEST SNCF N°49218 Ep.III

*Black roof, SNCF 306 green ends, modern
lantern holders, 3 headlights, South-West
SNCF N°49218 Era III*

*Grün, Dach schwarz, Signalhalter Neu,
3 Schlusslichter, Süd-West, SNCF
N°49218 Ep.III*



VB-341 toit noir, bouts verts 306,
porte lanterne moderne, 3 feux SUD-
OUEST SNCF, N°49240 Ep.III

*black roof, SNCF 306 green ends, modern
lantern holders, 3 headlights, South-West
SNCF N°49240 Era III*

*Grün, Dach schwarz, Signalhalter Neu, 3
Schlusslichter, Region Süd-West,
SNCF N°49240 Ep.III*



VB-342 Vvert 301, porte lanterne
moderne, 3 feux SUD-OUEST SNCF
N°50 87 93-17 704-1 Ep.IV

*SNCF 301 green, modern lantern holders,
3 headlights, South-West SNCF
N°50 87 93-17 704-1 Era IV*

*Grün, Signalhalter Neu, 3 Schlusslichter,
Region Süd-West, SNCF
N°50 87 93-17 704-1 Ep.IV*



VB-343 vert 301, porte lanterne
moderne, 3 feux, SUD-OUEST SNCF
N°50 87 93-17 737-1 Ep.IV

*SNCF 301 green, modern lantern holders,
3 headlights, South-West SNCF
N°50 87 93-17 737-1 Era IV*

*grün, Signalhalter Neu, 3 Schlusslichter,
Region Süd-West, SNCF
N°50 87 93-17 737-1 Ep.IV*



VB-344 vert 301, porte lanterne
moderne, 3 feux, SUD-OUEST SNCF
N°50 87 93-17 743-9 Ep.IV

*SNCF 301 green, modern lantern holders,
3 headlights, South-West SNCF
N°50 87 93-17 743-9 Era IV*

*Grün, Signalhalter Neu, 3 Schlusslichter,
Region Süd-West, SNCF
N°50 87 93-17 743-9 Ep.IV*



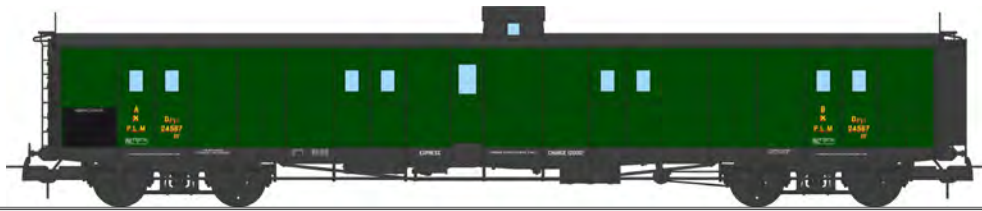

VB-345 vert PLM, vigie, échelle, toit et bouts noirs PLM N°24567 Ep.II

PLM green, Lookout box, Ladder, Black Roof and Ends PLM N°24567 Era II

Grün, Dachkanzel, Leiter, Dach und Stirnwand schwarz, PLM N°24567 Ep.II



VB-346 vert PLM, vigie, échelle, toit et bouts noirs PLM N°24593 Ep.II

PLM green, Lookout box, Ladder, Black Roof and Ends PLM N°24593 Era II

Grün, Dachkanzel, Leiter, Dach und Stirnwand schwarz, PLM N°24593 Ep.II



VB-347 vert PLM, vigie, échelle, toit et bouts noirs SNCF N°24636 Ep.III

PLM green, Lookout box, Ladder, Black Roof and Ends SNCF N°24636 Era III

grün, Dachkanzel, Leiter, Dach und Stirnwand schwarz, SNCF N°24636 Ep.III



VB-348 vigie, échelle, toit et bouts noirs, vert 306 SNCF N°24603 Ep.III

Lookout box, Ladder, Black Roof and Ends, SNCF 306 green, SNCF N°24603 Era III

Dachkanzel, Leiter, Dach und Stirnwand schwarz, grün, SNCF N°24603 Ep.III



VB-349 vigie, échelle, toit et bouts noirs, vert 306 SNCF N°24578 Ep.III

Lookout box, Ladder, Black Roof and Ends, SNCF 306 green, SNCF N°24578 Era III

Dachkanzel, Leiter, Dach und Stirnwand schwarz, grün, SNCF N°24578 Ep.III



VB-350 vigie, toit et bouts noirs,
petits marchepieds, vert 306 SNCF
N°58896 Ep.III

*Lookout box, Black Roof and Ends, Small steps,
SNCF 306 green, SNCF N°58896 Era III*

*Dachkanzel, Dach und Stirnwand schwarz, kleine
Trittbretter, grün, SNCF N°58807 Ep.III*



VB-351 toit noir,
petits marchepieds, vert 306 SNCF
N°58807 Ep.III

*Black Roof, Small steps, SNCF 306 green,
SNCF N°58807 Era III*

Dach schwarz, grün, SNCF N°58803 Ep.III



VB-352 toit noir,
vert 306 SNCF
N°58803 Ep.III

*Black Roof, SNCF 306 green,
SNCF N°58803 Era III*

Dach schwarz, grün, SNCF N°58803 Ep.III



VB-353 métallisé, toit noir,
vert 306 SNCF
N°58815 Ep.III

*Rebuilt out of metal, Black Roof, SNCF 306
green, SNCF N°58815 Era III*

*Stählerner Wagenkasten, Dach schwarz, grün,
SNCF N°58815 Ep.III*



VB-354 métallisé,
vert 306 SNCF
N°58812 Ep.III

*Rebuilt out of metal, SNCF 306 green,
SNCF N°58812 Era III*

*Stählerner Wagenkasten, grün,
SNCF N°58812 Ep.III*



VB-355 métallisé,
vert 301 SNCF
N°51 87 92-47 323-4 Ep.IV

*Rebuilt out of metal, SNCF 301 green,
SNCF N°51 87 92-47 323-4 Era IV*

*Stählerner Wagenkasten, grün,
SNCF N°51 87 92-47 323-4 Ep.IV*



VB-356 métallisé,
vert 301 SNCF
N°51 87 92-47 305-1 Ep.IV

*Rebuilt out of metal, SNCF 301 green,
SNCF N°51 87 92-47 305-1 Era IV*

*Stählerner Wagenkasten, grün,
SNCF N°51 87 92-47 305-1 Ep.IV*



Fourgon Bogie ex-PLM
ex-PLM luggage van · ex-PLM Gepäckwagen





Fourgon Bogie ex-PLM

ex-PLM luggage van • ex-PLM Gepäckwagen



VB-357 vert PLM, vigie, échelle, toit et bouts noirs PLM N°24559 Ep.II

PLM green, Lookout box, Ladder, Black Roof and Ends PLM N°24559 Era II

grün, Dachkanzel, Leiter, Dach und Stirnwand schwarz, PLM N°24559 Ep.II



VB-358 vigie, échelle, toit et bouts noirs, vert 306 SNCF N°24583 Ep.III

SNCF 306 green, Lookout box, Ladder, Black Roof and Ends N°24583 Era III

Dachkanzel, Leiter, Dach und Stirnwand schwarz, grün, SNCF N°24583 Ep.III



VB-359 vigie, toit et bouts noirs, petits marchepieds, vert 306 SNCF N°58821 Ep.III

Lookout box, Black Roof and Ends, Small steps, SNCF 306 green, SNCF N°58821 Era III

Dachkanzel, Dach und Stirnwand schwarz, kleine Trittbretter, grün, SNCF N°58821 Ep.III



VB-360 toit et bouts noirs, petits marchepieds, vert 306 SNCF N°58847 Ep.III

Lookout box, Black Roof and Ends, Small steps, SNCF 306 green, SNCF N°58847 Era III

Dach und Stirnwand schwarz, kleine Trittbretter, grün, SNCF N°58847 Ep.III



VB-361 toit et bouts noirs, petits marchepieds, vert 306 SNCF N°58831 Ep.III

Lookout box, Black Roof and Ends, Small steps, SNCF 306 green, SNCF N°58831 Era III

Dach und Stirnwand schwarz, kleine Trittbretter, grün, SNCF N°58831 Ep.III



VB-362 métallisé,
toit noir, vert 306 SNCF
N°58867 Ep.III

*Rebuilt out of metal, Black Roof, SNCF 306
green, SNCF N°58867 Era III*

*Stählermer Wagenkasten, Dach schwarz, grün,
SNCF N°58867 Ep.III*



VB-363 métallisé,
vert 306 SNCF
N°58878 Ep.III

*Rebuilt out of metal, SNCF 306 green,
SNCF N°58878 Era III*

*Stählermer Wagenkasten, grün,
SNCF N°58878 Ep.III*



VB-364 métallisé,
vert 301 SNCF
N°51 87 92-47 342-4 Ep.IV

*Rebuilt out of metal, SNCF 301 green,
SNCF N°51 87 92-47 342-4 Era IV*

*Stählermer Wagenkasten, grün,
SNCF N°51 87 92-47 342-4 Ep.IV*



VB-365 métallisé,
vert 301 SNCF
N°51 87 92-47 277-2 Ep.IV

*Rebuilt out of metal, SNCF 301 green,
SNCF N°51 87 92-47 277-2 Era IV*

*Stählermer Wagenkasten, grün,
SNCF N°51 87 92-47 277-2 Ep.IV*



Fourgon Bogie ex-PLM
ex-PLM luggage van · ex-PLM Gepäckwagen





VB-264 Coffret de 3 Voitures OCEM RA - PLM Ep.II, 1^{ère}/2^{ème} cl. A3B5yfi3475, 3^{ème} cl./fourgon C4Dyi12332, 3^{ème} cl. C9yfi12107
 Set of 3 OCEM RA coaches (1st/2nd class A3B5yfi 3475 + 3rd class/van C4Dyi 12332 + 3rd class C 9yfi 12107) PLM Ep.II
 Set aus 3 OCEM RA Wagen (1./2. Klasse A3B5yfi 3475 + 3. Klasse/Gepäck C4Dyi 12332 + 3. Klasse C 9yfi C 9yfi 12107) PLM Ep.II



VB-265
 3^{ème} classe C9yfi12204
 PLM Ep.II
 3rd class C 9yfi 12204 PLM Ep.II
 3. Klasse C 9yfi 12204 PLM Ep.II



VB-266
 1^{ère}/2^{ème} classe A3B5yfi 3483
 PLM Ep.II
 1st/2nd class A3B5yfi 3483 PLM Ep.II
 1./2. Klasse A3B5yfi3483 PLM Ep.II



VB-267 Coffret de 3 Voitures OCEM RA - Etat Ep.II - 3^{ème} cl. C9yfi18669 - 3^{ème} cl. C9yfi18684 - 3^{ème} cl./fourgon C4Dyi10967
 Set of 3 OCEM RA coaches (2 x 3rd class C 9yfi 18669, 18684 + 1 x 3rd class/van C4Dyi 10967) ETAT Ep.II
 Set aus 3 OCEM RA Wagen (2 x 3. Klasse C 9yfi 18669, 18684 + 1 x 3. Klasse/Gepäck C4Dyi 10967) ETAT Ep.II



VB-268
 3^{ème} classe C9yfi18748
 ETAT Ep.II
 3rd class C 9yfi 18748 ETAT Ep.II
 3. Klasse C 9yfi 18748 ÉTAT Ep.II



**VB-269 Coffret de 3 Voitures
OCEM RA**

SNCF Ep.III

1^{ère}/2^{ème} classe A3B5myfi 5849

2^{ème} classe B9myfi 54632

2^{ème} classe B9myfi 54694

Set of 3 OCEM RA coaches

1st/2nd class A3B5myfi 5849

2 x 2nd class B9myfi 54632, 54694

SNCF Ep.III

Set aus 3 OCEM RA Wagen

1 x 1./2. Klasse A3B5myfi 5849

2 x 2. Klasse B9myfi 54632, 54694

SNCF Ep.III



VB-270

3^{ème} cl./fourgon B4Dmyi 54317

SNCF Ep.III

3rd class/van B4Dmyi 54317 SNCF Ep.III

3. Klasse/Gepäck B4Dmyi54317 SNCF Ep.III



VB-271

2^{ème} classe B9myfi 54670

SNCF Ep.III

2nd class B9myfi 54670 SNCF Ep.III

2. Klasse B9myfi 54670 SNCF Ep.III



VB-272

3^{ème} classe/fourgon B4D
n°508782-40776-3 SNCF Ep.IV

3rd class/van B4D

50 87 82-40 776-3 SNCF Ep.IV

3. Klasse/Gepäck B4D

50 87 82-40 776-3 SNCF Ep.IV



VB-273

1^{ère}/2^{ème} classe A3B5
n°508738-47507-9 SNCF Ep.IV

1st/2nd class A3B5

50 87 38-47 507-9 SNCF Ep.IV

1./2. Klasse A3B5

50 87 38-47 507-9 SNCF Ep.IV





Voiture OCEM RA

OCEM RA coaches · OCEM RA Wagen



VB-274

1^{ère}/2^{ème} classe A3B5yfi 3020
MIDI Ep.II

1st/2nd class A3B5yfi 3020 MIDI Ep.II

1./2. Klasse A3B5yfi 3020 MIDI Ep.II



VB-275

1^{ère}/2^{ème} classe A3B5yfi 3034
MIDI Ep.II

1st/2nd class A3B5yfi 3034 MIDI Ep.II

1./2. Klasse A3B5yfi 3034 MIDI Ep.II

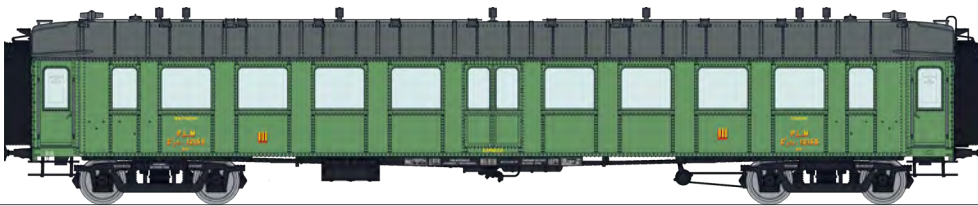

VB-276

3^{ème} classe C9yfi 12155
PLM Ep.II

3rd class C 9yfi 12155 PLM Ep.II

3. Klasse C 9yfi 12155 PLM Ep.II

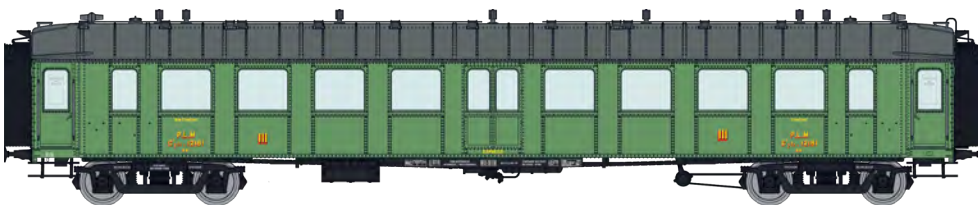

VB-277

3^{ème} classe C9yfi 12181
PLM Ep.II

3rd class C9yfi 12181 PLM Ep.II

3. Klasse C9yfi 12181 PLM Ep.II



VB-278

3^{ème} classe/fourgon C4Dyi 12368
PLM Ep.II

3rd class/van C4Dyi 12368 PLM Ep.II

3. Klasse/Gepäck C4Dyi 12368 PLM Ep.II



**VB-279 Coffret de
3 Voitures OCEM RA**

AL Ep.II
3^{ème} cl. C9yfi11205
3^{ème} cl. C9yfi11207
3^{ème} cl./fourgon C4Dyi11906

*Set of 3 OCEM RA coaches
2 x 3rd class C 9yfi 11205, 11207
1 x 3rd class/van C4Dyi 11906 AL Ep.II*

*SET aus 3 OCEM RA Wagen
2 x 3. Klasse C 9yfi 11205, 11207
1 x 3. Klasse/Gepäck C4Dyi 11906) AL Ep.II*



VB-280

3^{ème} classe C9yfi 11219
AL Ep.II
3rd class C9yfi 11219 AL Ep.II
3. Klasse C 9yfi 11219 AL Ep.II



**VB-281 Coffret de
3 Voitures OCEM RA**

1^{ère}/2^{ème} cl. A3B5myfi 3469
2^{ème} cl. C9myfi 12114
3^{ème} classe/fourgon B4Dmyi 12338

*Set of 3 OCEM RA coaches Black Roof
1st/2nd class A3B5myfi 3469
2nd class C9myfi 12114
3rd class/van B4Dmyi 12338
SNCF Ep.III*

*SET aus 3 OCEM RA Wagen Dach schwarz
1./2. Klasse A3B5myfi 3469
2. Klasse C9myfi 12114
3. Klasse/Gepäck B4Dmyi 12338
SNCF Ep.III*

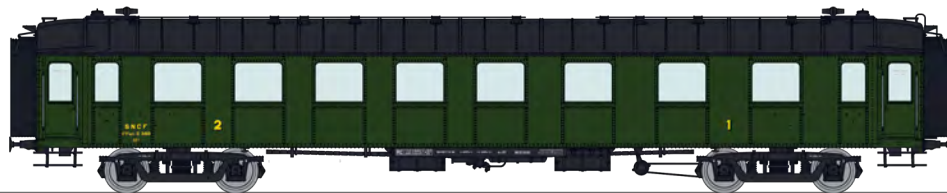

VB-282

Toit noir 3^{ème} classe C9myfi
n°12137 SNCF Ep.III
3rd class black roof C9myfi 12137 SNCF Ep.III
Dach schwarz 3.Kl C9myfi 12137 SNCF Ep.III



VB-283

Toit vert 1^{ère}/2^{ème} classe A3B5myfi
n°5870 SNCF Ep.III
1st/2nd cl. green roof A3B5myfi 5870 SNCF Ep.III
Dach grün 1./2.Kl. A3B5myfi 5870 SNCF Ep.III





VB-079

rouge foncé, châssis noir, toit gris clair, échelle, bogie Y2 PAyi N°43502 Ep.II MIDI

Dark red, black frame, light grey roof, ladder, Y2 bogies PAyi N°43502 Ep.II MIDI

Dunkelrot, Rahmen schwarz, Dach hellgrau, Y2 Drehgestelle, PAyi N°43502 Ep.II MIDI



VB-080

rouge foncé, châssis noir, toit gris clair, échelle, bogie Y2 PAyi N°45613 Ep.II PLM (1935)

Dark red, black frame, light grey roof, ladder, Y2 bogies PAyi N°45613 Ep.II PLM (1935)

Dunkelrot, Rahmen schwarz, Dach hellgrau, Leiter, Y2 Drehgestelle, PAyi N°45613 Ep.II PLM



VB-081

rouge foncé, châssis noir, toit gris clair, échelle, bogie Y2 PAyi N°41510 Ep.II EST (1935)

Dark red, black frame, light grey roof, ladder, Y2 bogies PAyi N°41510 Ep.II EST (1935)

Dunkelrot, Rahmen schwarz, Dach hellgrau, Leiter, Y2 Drehgestelle, PAyi N°41510 Ep.II EST



VB-082

rouge foncé, châssis noir, toit gris clair, échelle, bogie Y2 PAyi N°44541 Ep.II NORD (1935)

Dark red, black frame, light grey roof, ladder, Y2 bogies PAyi N°44541 Ep.II NORD (1935)

Dunkelrot, Rahmen schwarz, Dach hellgrau, Leiter, Y2 Drehgestelle, PAyi N°44541 Ep.II NORD (1935)

VB-083

rouge foncé, châssis noir, toit gris clair, échelle, bogie Y2 PAyi N°45621 Ep.III A

Dark red, black frame, light grey roof, ladder, Y2 bogies PAyi N°45621 Ep.III A

Dunkelrot, Rahmen schwarz, Dach hellgrau, Leiter, Y2 Drehgestelle, PAyi N°45621 Ep.III A



VB-084

brun PTT, châssis noir, toit gris, bogie Y2 PAyi N°47519 Ep.III

PTT brown, black frame, grey roof, Y2 bogies PAyi N°47519 Ep.III

PTT braun, Rahmen schwarz, Dach grau, Y2 Drehgestelle, PAyi N°47519 Ep.III



VB-085

brun PTT, châssis noir, bogie Y2 PAyi N°45562 Ep.III

PTT brown, black frame, grey roof, Y2 bogies PAyi N°45562 Ep.III

PTT braun, Rahmen schwarz, Y2 Drehgestelle, PAyi N°45562 Ep.III



VB-086

brun PTT, châssis et toit gris, bogie Y2 boîtes à rouleaux PAz N°50 87 00 37 127-3 Ep.IV

PTT brown, grey roof and frame, Y2 bogies roller bearings PAz N°50 87 00 37 127-3 Ep.IV

PTT braun, Rahmen und Dach grau, Y2 Drehgestelle, Rollenachslager, PAz N°50 87 00 37 127-3 Ep.IV



VB-087

brun PTT, châssis gris, bogie Y2 boîtes à rouleaux PAz N°50 87 00 47 210-3 Ep.IV

PTT brown, grey frame, Y2 bogies roller bearings PAz N°50 87 00 47 210-3 Ep.IV

PTT braun, Rahmen grau, Y2 Drehgestelle, Rollenachslager, PAz N°50 87 00 47 210-3 Ep.IV



Postale 21,6 m
Mail cars · Postwagen



VB-089

brun PTT, châssis gris bogie Y2, soufflet, PAz N°50 87 00-77 283-5 Ep.IV

PTT brown, grey frame, Y2 bogies, bellows, PAz N°50 87 00-77 283-5 Ep.IV

PTT braun, Rahmen grau, Y2 Drehgestelle, Faltenbalg, PAz N°50 87 00-77 283-5 Ep.IV



VB-090

brun PTT, châssis gris bogie Y2, bourrelet UIC, PAz N°50 87 00-77 124-1 Ep.IV

PTT brown, grey frame, Y2 bogies, UIC gangway beads, PAz N°50 87 00-77 124-1 Ep.IV

PTT braun, Rahmen grau, Y2 Drehgestelle, UIC Gummivulst, PAz N°50 87 00-77 124-1 Ep.IV



VB-091

brun PTT, châssis gris bogie Y2, bourrelet UIC, PAz N°50 87 00-77 421-1 Ep.IV

PTT brown, grey frame, Y2 bogies, UIC gangway beads, PAz N°50 87 00-77 421-1 Ep.IV

PTT braun, Rahmen grau, Y2 Drehgestelle, UIC Gummivulst, PAz N°50 87 00-77 421-1 Ep.IV



VB-092

jaune intermédiaire, châssis gris bogie Y24, soufflet, PEz N°50 87 00-85 547-3 Ep.IV

Stowage Van, transitional yellow, grey frame, Y24 bogies, bellows, PEz N°50 87 00-85 547-3 Ep.IV

Gelb, Rahmen grau, Y24 Drehgestelle, Faltenbalg, PEz N°50 87 00-85 547-3 Ep.IV

VB-093

brun PTT, châssis gris bogie Y24,
bourrelet UIC,
PEz N°50 87 00-87 556-2 Ep.IV

*Stowage Van, PTT brown, grey frame, Y24
bogies, UIC gangway beads, PEz
N°50 87 00-87 556-2 Ep.IV*

*PTT braun, Rahmen grau, Y24 Drehgestelle, UIC
Gummivulst, PEz N°50 87 00-87 556-2 Ep.IV*



VB-094

brun PTT, châssis gris bogie Y24,
soufflet,
PEz N°50 87 00-77 583-8 Ep.IV

*Stowage Van, PTT brown, grey frame, Y24
bogies, bellows, PEz N°50 87 00-77 583-8
Ep.IV*

*PTT braun, Rahmen grau, Y24 Drehgestelle,
Faltenbalg, PEz N°50 87 00-77 583-8 Ep.IV*



VB-095

brun PTT, châssis noir et toit gris,
bogie Y2, soufflet, PEz N°45757 Ep.III

*Stowage Van, PTT brown, black frame, grey roof,
Y2 bogies, bellows, PEz N°45757 Ep.III*

*PTT braun, Rahmen schwarz und Dach grau, Y2
Drehgestelle, Faltenbalg, PEz N°45757 Ep.III*



VB-096

brun PTT, châssis gris bogie Y24,
soufflet, PEz N°50 87 00-47 516-5
Ep.IV

*Stowage Van, PTT brown, grey frame, Y24
bogies, bellows, PEz N°50 87 00-47 516-5
Ep.IV*

*PTT braun, Rahmen grau, Y24 Drehgestelle,
Faltenbalg, PEz N°50 87 00-47 516-5 Ep.IV*



VB-097

brun PTT, châssis gris bogie Y2, soufflet,
«Presse Parisienne»
PAz N°50 87 00-60 317-6 Ep.IV

*PTT brown, grey frame, Y2 bogies, bellows,
«Presse parisienne» PAz N°50 87 00-60 317-6
Ep.IV*

*PTT braun, Rahmen grau, Y2 Drehgestelle,
Faltenbalg, «Presse parisienne»
PAz N°50 87 00-60 317-6 Ep.IV*





VB-247 AMBULANT OCEM 16 m

PAmyi rouge foncé, toit gris clair, Bogie Y2, N° 45907 Ep.III A

PAmyi dark red, light grey roof, Y2 Bogie, N° 45907 Ep.III A

PAmyi dunkelrot, Dach hellgrau, Y2 Drehgestelle, N° 45907 Ep.III A



VB-248 AMBULANT OCEM 16 m

PAmyi brun PTT, toit gris, bogie Y2, N° 46572 Ep.III B

PAmyi PTT brown, grey roof, Y2 Bogie, N° 46572 Ep.III B

PAmyi PTT braun, Dach grau, Y2 Drehgestelle, N° 46572 Ep.III B



VB-249 AMBULANT OCEM 16 m

brun PTT, toit gris, bogie Y2, N° 45918 Ep.III B

PAmyi PTT brown, grey roof, Y2 Bogie, N° 45918 Ep.III B

PAmyi PTT braun, Dach grau, Y2 Drehgestelle, N° 45918 Ep.III B



VB-250 AMBULANT OCEM 16 m

PAZ brun PTT, châssis gris, bogie Y2, N° 50 87 00 47 905-0 Ep.IV

PTT brown, grey frame, Y2 Bogie, N° 50 87 00 47 905-0 Ep.IV

PTT braun, Rahmen grau, Y2 Drehgestelle, N° 50 87 00 47 905-0 Ep.IV



VB-251 AMBULANT OCEM 16 m

PAZ brun PTT, châssis gris, bogie Y2, N° 50 87 00 47 935-4 Ep.IV

PTT brown, grey frame, Y2 Bogie, bogie Y2, N° 50 87 00 47 935-4 Ep.IV

PTT braun, Rahmen grau, Y2 Drehgestelle, N° 50 87 00 47 935-4 Ep.IV



VB-252 ALLÈGE OCEM 16 m

Transformation Allemande PEZ brun PTT, toit gris, châssis noir, bogie Y2, N° 42787 Ep.III B

German conversion PEZ PTT brown, grey roof black frame, Y2 bogie, N° 42787 Ep.III B

Deutscher Umbau PEZ PTT braun, Dach grau, Rahmen schwarz, Y2 Drehgestelle, N° 42787 Ep.III B



VB-253 ALLÈGE OCEM 16 m

Transformation Allemande PEZ brun PTT, toit gris, châssis noir, bogie Y2, N° 42792 Ep.III B

German conversion PEZ PTT brown, grey roof black frame, Y2 bogie, N° 42792 Ep.III B

Deutscher Umbau PEZ PTT braun, Dach grau, Rahmen schwarz, Y2 Drehgestelle, N° 42792 Ep.III B

VB-254 ALLÈGE OCEM 16 m

PAmyi rouge foncé, toit gris clair,
Bogie Y2, N° 45907 Ep.III A

*German conversion PEZ PTT brown, grey frame,
Y2 bogie, N° 50 87 00-47 915-4 Ep.IV
Deutscher Umbau PEZ PTT braun, Rahmen grau,
Y2 Drehgestelle, N° 50 87 00-47 915-4 Ep.IV*

**VB-255 ALLÈGE PANTIN PEZ**

brun PTT, châssis gris, bogie Y2,
N° 50 87 00-37 937-5 Ep.IV

*PTT brown, grey frame, Y2 bogie,
N° 50 87 00-37 937-5 Ep.IV
PTT braun, Rahmen grau, Y2 Drehgestelle,
N° 50 87 00-37 937-5 Ep.IV*

**VB-256 ALLÈGE PANTIN PEZ**

brun PTT, châssis gris, bogie Y2,
N° 50 87 00-37 940-7 Ep.IV

*PTT brown, grey frame, Y2 bogie,
N° 50 87 00-37 940-7 Ep.IV
PTT braun, Rahmen grau, Y2 Drehgestelle,
N° 50 87 00-37 940-7 Ep.IV*

**VB-257 ALLÈGE PANTIN PEZ**

brun PTT, châssis gris, protection
caoutchouc, sans soufflet, bogie Y2,
N° 50 87 00-47 939-9 Ep.IV

*PTT brown, grey frame, rubber protection,
without bellow, Y2 bogie, Ep.IV
PTT braun, Rahmen grau, Gummiummantelung,
ohne Faltenbalg, Y2 Drehgestelle, Ep.IV*

**VB-258 ALLÈGE PANTIN PEZ**

brun PTT, châssis gris, protection
caoutchouc, sans soufflet, bogie Y2,
N° 50 87 00-37 928-4 Ep.IV

*PTT brown, grey frame, rubber protection,
without bellow, Y2 bogie
PTT Braun, Rahmen grau, Gummiummantelung,
ohne Faltenbalg, Y2 Drehgestelle*

**VB-259 AMBULANT OCEM 16 m**

PAyi roue foncé, toit gris clair, bogie
Y2, N° 45913 Ep.II - PLM

*PAyi dark red, light grey roof, Y2 Bogie,
N° 45913 Ep.II - PLM
PAyi dunkelrot, Dach hellgrau, Y2 Drehgestelle,
N° 45913 Ep.II - PLM*

**VB-260 AMBULANT OCEM 16 m**

PAyi rouge foncé, toit gris clair,
bogie Y2, N° 46902 Ep.II - PO

*PAyi dark red, light grey roof, Y2 Bogie,
N° 46902 Ep.II - PO
PAyi dunkelrot, Dach hellgrau, Y2 Drehgestelle,
N° 46902 Ep.II - PO*

**VB-261 AMBULANT OCEM 16 m**

PAyi rouge foncé, toit gris clair,
bogie Y2, N° 44904 Ep.II - NORD

*PAyi dark red, light grey roof, Y2 Bogie,
N° 44904 Ep.II - NORD
PAyi dunkelrot, Dach hellgrau, Y2 Drehgestelle,
N° 44904 Ep.II - NORD*

**VB-262 ALLÈGE OCEM 16 m**

Pantin PAZ Jaune et Blanc
protection caoutchouc,

N° 50 87 00-47 932-4 Ep.IV-V
*PAZ Yellow/White, rubber protection,
N° 50 87 00-47 906-8 Ep.IV-V
PAZ Gelb/Weiß Gummiummantelung,
N° 50 87 00-47 906-8 Ep.IV-V*





LES VOITURES PLM À BOGIES MÉTALLISATION 26



Complément indispensable de nos voitures Bacalan, OCEM RA et fourgons PLM.

Ces voitures sont emblématiques des trains de voyageurs des années 30 à la fin des années 60.

Les voitures issues de la métallisation en 1926 :

- Première classe : A7
- Mixte 1^{ère}/2^{nde} : A3B4
- Seconde classe : B8

...et de belles voitures Lits-Salon A2LB4 !

*Essential to complement our Bacalan, OCEM RA and PLM luggage cars. Those cars are iconic of trains from the 30's to the end of 60's.
Unverzichtbare Ergänzung zu unseren Bacalan und OCEM RA Reisezugwagen sowie PLM Gepäckwagen. Diese Wagen sind das Wahrzeichen der Personenzüge von den 1930er bis Ende der 1960er Jahre.*

*Passengers cars coming from 1926's metallization: first class : A7, mix 1st/ 2nd : A3B4, Second class : B8
Die Wagen stammen aus dem Umbau von 1926: Erste Klasse: A7, Gemischt 1./2. : A3B4, Zweite Klasse: B8*

*And beautiful beds-living cars A2LB4!
Und schöne Salon-Liegewagen A2LB4!*

PLM métalisée

PLM passengers cars • PLM Drehgestellwagen



LES VOITURES PLM À BOGIES MODERNISATION DES ANNÉES 60



Complément indispensable de nos voitures DEV AO, OCEM RA et UIC.

Ces voitures mixtes fourgons sont omniprésentes dans les trains de voyageurs des années 60 à la fin des années 80.

Les voitures modernisées Sud-Est :

- Mixte 1^{ère}/ fourgon : A4d
- Mixte 2nde/ fourgon : B4d

...sans oublier les voitures d'origine en bois !



Essential to complement our DEV AO, OCEM RA and UIC cars. Those mix luggage/passengers cars are on all the passengers trains from the 60's to end of 80's.
Unverzichtbare Ergänzung zu unseren DEV AO, OCEM RA und UIC Reisezugwagen. Diese Wagen mit Gepäckabteil sind allgegenwärtig in den Personenzügen von den 1960er bis Ende der 1980er Jahre.

Passengers cars called "Modernized SOUTH-EAST" : mix 1st / luggage : A4d, mix 2nd / luggage : b4d
Die modernisierten SE Wagen : gemischt 1. Klasse / Gepäck : A4d, Gemischt 2. Klasse / Gepäck : B4d

Without forgetting the wood cars from the origin!
Nicht zu vergessen die Ursprungsversion mit Holzaufbau!



REE
MODELES
La différence...



Voiture Bacalan
«Bacalan» coaches · BacalanWagen



VB-366
3^{ème} classe C11yfi 11365
PLM Ep.II
3rd class C11yfi 11365 PLM Ep.II
3. Klasse C11yfi 11365 PLM Ep.II



VB-367
Buffet C4s 12418
PLM Ep.II
Buffet C4s 12418 PLM Ep.II
Büffet C4s 12418 PLM Ep.II



VB-368
3^{ème} classe C11 myfi 11450 SNCF
Ep.III-A, toit noir, échelles
3rd class C11 myfi 11450 SNCF Ep.III-A
black roof, ladders
3. Klasse C11 myfi 11450 SNCF Ep.III-A
Dach schwarz, Leitern



VB-369
3^{ème} classe C11 myfi 12452 SNCF
Ep.III-A, toit noir
3rd class C11 myfi 12452 SNCF
Ep.III-A black roof
3. Klasse C11 myfi 12452 SNCF
Ep.III-A Dach schwarz



VB-370
Buffet C4s 12419 SNCF Ep.III-A
toit noir, échelles
Buffet C4s 12419 SNCF Ep.III-A
black roof, ladders
Büffet C4s 12419 SNCF Ep.III-A
Dach schwarz, Leitern



VB-372
2^{ème} classe B11 myfi 54832 SNCF
Ep.III-B
2nd class B11 myfi 54832 SNCF Ep.III-B
2. Klasse B11 myfi 54832 SNCF Ep.III-B



VB-373
Buffet B3r 54863 SNCF Ep.III-B
Buffet B3r 54863 SNCF Ep.III-B
Büffet B3r 54863 SNCF Ep.III-B



VB-371
Set de 3 Voitures BACALAN

SNCF Ep.III-B
2^{ème} classe B11myfi 54820
2^{ème} classe B11myfi 54759
Buffet B3r 54861

Set of 3 BACALAN Coaches
2 x 2nd classe B11myfi 54820, 54759
1 x Buffet B3r 54861
SNCF Ep.III-B

Set aus 3 BACALAN Wagen
2 x 2. Klasse B11myfi 54820, 54759
1 x Buffet B3r 54861
SNCF Ep.III-B



VB-374

Coffret de 3 Voitures

SNCF Ep.IV logo encadré jaune
2^{ème} classe B11 51 87 21-47 517-7
2^{ème} classe B11 51 87 21-47 562-3
Buffet B3r 51 87 85-47 115-3

Set of 3 BACALAN coaches
Boxed yellow logo
2 x 2nd classe B11 51 87 21-47 517-7,
51 87 21-47 562-3
1 x Buffet B3r 51 87 85-47 115-3
SNCF Ep.IV

Set aus 3 BACALAN Wagen
gelbes SNCF Zeichen
2 x 2. Klasse B11 51 87 21-47 517-7,
51 87 21-47 562-3
1 x Buffet B3r 51 87 85-47 115-3
SNCF Ep.IV

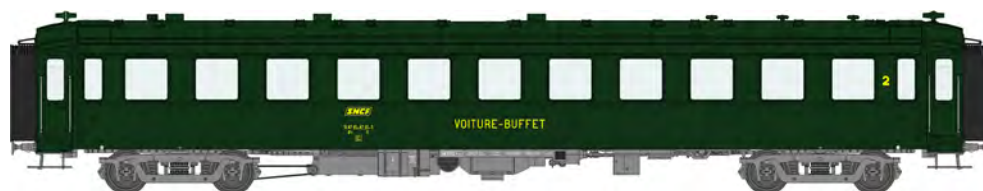

VB-375

2^{ème} classe B11 51 87 21-47 553-2
SNCF Ep.IV logo encadré jaune
2nd class B11 51 87 21-47 553-2 SNCF
Ep.IV boxed yellow SNCF logo

2. Klasse B1151 87 21-47 553-2 SNCF
Ep.IV gelbes SNCF Zeichen



VB-376

Buffet B3r 51 87 85-47 112-0
SNCF Ep.IV logo encadré jaune
Buffet B3r 51 87 85-47 112-0
Ep.IV boxed yellow SNCF logo

Buffet B3r 51 87 85-47 112-0
Ep.IV gelbes SNCF Zeichen

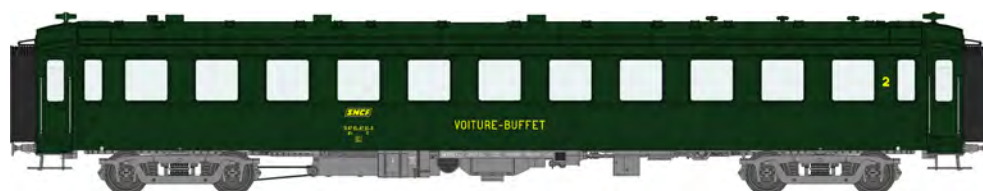

VB-377

2^{ème} classe B11 50 87 21-47 580-6
SNCF Ep.IV cartouche Corail
2nd class B11 50 87 21-47 580-6
SNCF Ep.IV « cartouche Corail » class signage
2. Klasse B1150 87 21-47 580-6
SNCF Ep.IV Corail Schriftzug





Voiture Bacalan

«Bacalan» coaches · BacalanWagen



VB-235
Coffret 3 voitures
B11 Vert 301, châssis gris,
Logo encadré jaune Ep.IV SNCF

*Set of 3 « Bacalan » Coaches
B11 SNCF 301 green, grey frame,
boxed yellow SNCF logo Ep.IV SNCF*

*Set aus 3 « Bacalan » Wagen
B11 grün, Rahmen grau, gelbes SNCF
Zeichen Ep.IV SNCF*

VB-238
Coffret 3 voitures
B11 Vert 301, châssis gris,
Cartouches Corail Ep.IV-V SNCF

*Set of 3 « Bacalan » Coaches
B11 SNCF 301 green, grey frame,
« Cartouches Corail » class signage
Ep.IV-V SNCF*

*Set aus 3 « Bacalan » Wagen
B11 grün, Rahmen grau,
Corail Schriftzug Ep.IV-V SNCF*



VB-137

Coffret 3 voitures

DEV AO Courtes
2 x C10 U52 + 1 x A8 U53
Vert SNCF 306, Châssis noir
Ep.III-A

*Set of 3 short DEVAO COACHES
2x C10 U52 + 1xA8 U53
SNCF 306 green
Black Frame- Ep.III-A*

*Set aus 3 DEVAO Personenwagen
2x C10 U52 + 1xA8 U53
kurze Bauart, grün,
schwarzer Rahmen, Ep.III-A*



VB-138

A8 U53 Vert SNCF 306,
Châssis noir Ep.III A

*A8 U53 Vert SNCF 306, SNCF 306 green,
Black Frame Ep.III-A*

*A8 U53, kurze Bauart, grün,
schwarzer Rahmen, Ep.III A*



VB-144

B8ex-A8 U53 Vert Garrigue 302
Encadré Cartouche Corail - Ep.V

*B8ex-A8 U53 SNCF 302
green «Vert Garrigue» Boxed SNCF logo
«Cartouche Corail» class signage Ep.V*

*B8ex-A8 U53, kurze Bauart, grün
Corail Schriftzug, Ep.V*



VB-145

A8 U53 Vert Garrigue 302 / Gris
béton Logo Encadré Cartouche
Corail Ep.V

*A8 U53 SNCF 302 «Vert Garrigue» green
/ «Gris Béton» grey, Boxed SNCF logo,
«Cartouche Corail» class signage Ep.V
A8 U53, kurze Bauart, grün/grau,
Corail Schriftzug, Ep.V*



Voiture DEVAO
DEVAO coaches · DEVAO Personenwagen



VB-132

Coffret 3 voitures

B10 U46 Vert Celtique 301, châssis gris, jupe échancrée devant les bogies
Logo encadré jaune Ep.IV

Set of 3 Short DEVAO Coaches B10 U46 SNCF 301 green , grey frame, skirts cut in front of bogies, Boxed yellow SNCF logo Ep.IV

Set aus 3 DEVAO Wagen, Kurz, B10 U46, grün, Rahmen grau, hochgezogene Schürze vor den Drehgestellen, gelbes SNCF Zeichen, Ep.IV



VB-134

Coffret 3 voitures

B10 U46 Vert Celtique 301, châssis gris, jupe échancrée devant les bogies
Logo Encadré Cartouche Corail Ep.V

Set of 3 Short DEVAO Coaches B10 U46 SNCF 301 green , grey frame, skirts cut in front of bogies, Boxed yellow SNCF logo, « Cartouche Corail » class signage, Ep.V

Set aus 3 DEVAO Wagen, Kurz, B10 U46, grün, Rahmen grau, hochgezogene Schürze vor den Drehgestellen, Corail Schriftzug, Ep.V



VB-195

Coffret 3 voitures

1 x C10 + 2 A21/2B6 Vert 306,
châssis noir, Toit noir,
Origine avec jupe totale Ep.III A
REE COLLECTION (R=525 mm)

*Set of 3 DEVAO U46
1 x C10 + 2 A21/2B6 coaches,
SNCF 306 green, black frame and roof,
Original condition with uncut skirts Ep.III A*

*Set aus 3 DEVAO Wagen
1 x C10 + 2 A21/2B6
grün, Rahmen und Dach schwarz,
komplette Umlaufschürze Ep.III A*



VB-197

A21/2B6 Vert SNCF 306, châssis
noir, toit noir, jupe échancrée
devant les bogies Ep.III A

*A21/2B6 Coach SNCF 306 green, black
frame and roof, skirts cut in front of bogies,*

*A21/2B6 grün, Rahmen und Dach schwarz,
hochgezogene Schürze
vor den Drehgestellen Ep.III A*



VB-198

Coffret 3 voitures

1 x B10 + 2 A21/2B6 Vert SNCF
306, châssis noir, toit vert,
jupe échancrée devant les bogies
Ep.III B

*Set of 3 DEVAO U46 Coaches
1 x B10 + 2 A21/2B6
SNCF 306 green, black frame, green roof,
skirts cut in front of bogies, Ep.III B*

*Set aus 3 DEVAO Wagen
1 x B10 + 2 A21/2B6,
grün, Rahmen schwarz, Dach grün,
hochgezogene Schürze vor den
Drehgestellen Ep.III B*



VB-200

Coffret 2 voitures

(2 A21/2B6) Vert 301, châssis
gris, toit vert, jupe échancrée
devant les bogies,
logo encadré jaune Ep.IV

*Set of 2 DEVAO Coaches U46
2 A21/2B6 SNCF 301 green, grey frame,
green roof skirts cut in front of bogies, Boxed
yellow SNCF logo Ep.IV*

*Set aus 2 DEVAO U46
2 A21/2B6, grün, Rahmen grau, Dach grün,
hochgezogene Schürze vor den
Drehgestellen, gelbes SNCF Zeichen Ep.IV*





VB-154

ex-B6q VB Rouge, toit rouge, petites gouttières
Ep.IV-V (N° 30 87 959 0 638-4)

*ex-B6q VB Red, red roof, small gutters Ep.IV-V
N° 30 87 959 0 638-4 - (RE-RUN)*

*ex-B6q VB Rot, Dach rot, Regenrinne klein Ep.IV-V
N° 30 87 959 0 638-4 - (WIEDERAUFLAGE)*



VB-155

ex-B6q VB Rouge, toit noir, petites gouttières
Ep.IV-V (N° 30 87 949 1 279-7)

*ex-B6q VB Red, black roof, small gutters Ep.IV-V
N° 30 87 949 1 279-7 (RE-RUN)*

*ex-B6q VB Rot, Dach schwarz, Regenrinne klein Ep.IV-V
N° 30 87 949 1 279-7 (WIEDERAUFLAGE)*



VB-240

Coffret 3 voitures

16m 1 porte Ep.III A
2 x B6t N°41792 et 41807
1 x B3C3t N°42757

*Set of 3 SO modernized Coaches, 16m,
1 door Ep.III A
2 x B6t N°41792 and 41807
1 x B3C3t N°42757*



*Set aus 3 SW, 16m
1 Tür Ep.III A
2 x B6t N°41792 und 41807
1 x B3C3t N°42757*



VB-241

16m 1 porte Ep.III-A
B6t N°41809

Modernized Coach, 16m, 1 door Ep.III A B6t N°41809



16m 1 Tür Ep.III-A B6t N°41809



VB-242

Coffret 3 voitures

16m 2 portes Ep.III-B
2 x A2B3t N°40824 et 40829
1 x Fourgon B4Dq N°46719

*Set of 3 SO modernized Coaches, 16m,
2 doors Ep.III-B
2 x A2B3t N°40824 and 40829
1 x Van B4Dq N°46719*

*Set aus 3 SW, 16m 2 Türen Ep.III-B
2 x A2B3t N°40824 und 40829
1 x Gepäck B4Dq N°46719*



VB-243

16m 2 portes Ep.III-B
A2B3t N°42816

16m, 2 doors Ep.III B A2B3t N°42816

16m 2 Türen Ep.III B A2B3t N°42816



VB-244

Coffret 3 voitures

15m 2 portes TOIT HAUT Ep.III B
2 x B6t N°46972 et 47345
16 m Fourgon B4Dq N°46723

*Set of 3 SO modernized Coaches, 15m,
2 doors, High Roof Ep.III-B
2 x B6t N°46972 and 47345
1 x 16 m Van B4Dq N°46723*

*Set aus 3 SW, 15m 2 Türen, hohes Dach
Ep.III-B
2 x B6t N°46972 und 47345
1 x 16 m Gepäck B4Dq N°46723*



VB-245

15m 2 portes B6t, Toit haut,
Ep.III-B (N°47067)

15m, 2 doors B6t High Roof Ep.III B (N°47067)

15m 2 Türen B6t, hohes Dach Ep.III B (N°47067)

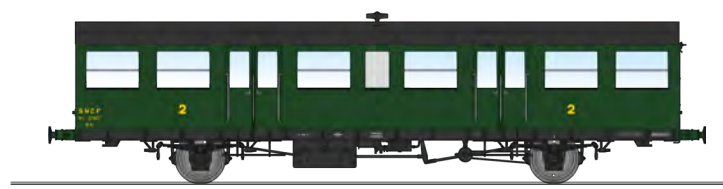

VB-246

Remorque Autorail Rouge et Crème,
Grande gouttière Ep.III-B (XR 9807)

Trailer Red/Cream, large gutters Ep.III B (XR 9807)

Triebwagen, rot und creme, Regenrinne Groß, (XR 9807)

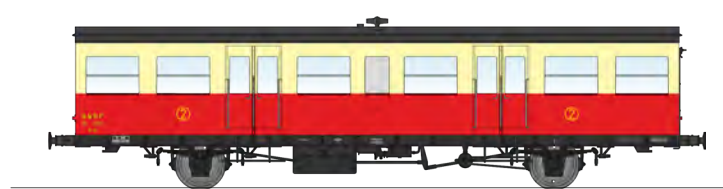

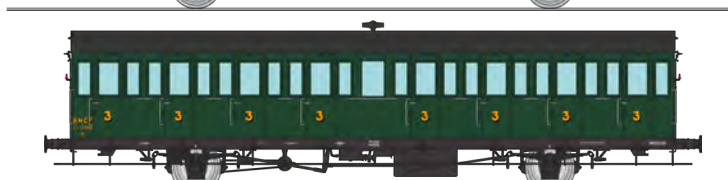

VB-284

Coffret 3 voitures

Portières latérales 15 mètres
3^{ème} classe C8t n° 15650, 15684 et 15701
MIDI Ep. II

*Set of 3 15 meters 3rd class compartment coaches
C8t n° 15650, 15684 and 15701 MIDI Ep. II*

*Set aus 3 Abteilwagen 15 m 3. Klasse C8t
n° 15650, 15684 et 15701 MIDI Ep. II*

VB-285

Portières latérales 15 mètres MIDI 3^{ème} classe C8t
n° 15715, Ep. II

15 meters 3rd class compartment coach MIDI C8t n° 15715,

Abteilwagen 15 m MIDI 3. Klasse C8t n° 15715, Ep. II

VB-286

Coffret 3 voitures

Portières latérales 15 mètres
3^{ème} classe C8S n° 31048, 31050, et 34870 P.O.
Ep. II

*Set of 3 15 meters 3rd class compartment coaches C8S
n° 31048, 31050 and 34870 Paris-Orléans Railways Ep. II*

*Set aus 3 Abteilwagen 15 m 3. Klasse C8S
n° 31048, 31050, et 34870 P.O. Ep. II*

VB-287

Portières latérales 15 mètres
P.O. 3^{ème} classe C8S n° 34900, Ep. II

3rd class compartment coach C8S P.O. n° 34900, Ep. II

P.O. 3. Klasse C8S n° 34900, Ep. II

VB-289

Portières latérales 15 mètres
SNCF ex-MIDI 3^{ème} classe C8t n° 47880, Ep. III A
3rd class compartment coach ex-MIDI, SNCF C8t n° 47880

SNCF ex-MIDI 3. Klasse C8t n° 47880, Ep. III A

VB-288
Coffret 3 voitures
 Portières latérales 15 mètres
 2 x 3^{ème} classe C8t n°47874 et 47909 ex-MIDI
 1 x C8t n°47185,
 ex P.O. SNCF, Ep. III-A

*Set of 3 3rd class compartment coaches C8t
 n° 47874, 47909 ex-MIDI and 1 C8t n° 47185,
 ex- P.O. SNCF, Ep. III-A*

*Set aus 3 3. Klasse C8t n° 47874 et 47909
 ex MIDI und 1 C8t n° 47185, ex P.O. SNCF, Ep. III-A*

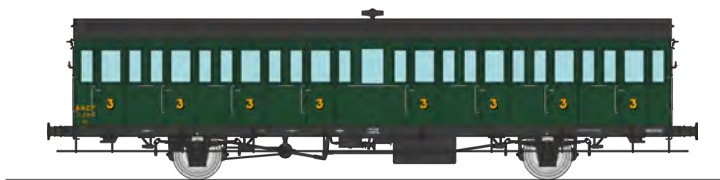

VB-290

3^{ème} classe C8t n°47212, Ep. III-A
 3rd class compartment coach SNCF ex- P.O. C8t
 n° 47212, Ep. III-A

SNCF ex P.O. 3. Klasse C8t n° 47212, Ep. III-A



VB-291

Coffret 3 voitures

Portières latérales 15 mètres 2^{ème} classe B8t
 n°47876 et 47890, ex-MIDI
 + 1 B8t n° 47195, ex P.O. SNCF Ep. III-B

*SET of 3 2nd class compartment coaches
 B8t n° 47876 and 47890, ex-MIDI
 + 1 B8t n° 47195, ex- P.O. SNCF Ep. III-B*

*Set aus 3 2. Klasse B8t n° 47876 et 47890,
 ex MIDI + 1 B8t n° 47195, ex P.O. SNCF Ep. III-B*

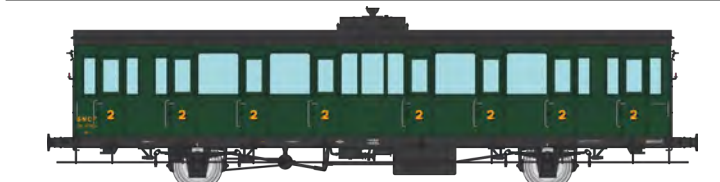

VB-292

SNCF ex-MIDI 2^{ème} classe
 B8t n°47913, Ep. III-B

*2nd class compartment coach ex-MIDI,
 B8t n° 47913, Ep. III-B
 SNCF ex-MIDI 2. Klasse B8t n° 47913, Ep. III B*



VB-293

ex-P.O. 2^{ème} classe
 B8t n°47220 Ep. III-B

*2nd class compartment coach ex-P.O.,
 B8t n° 47220, Ep. III-B
 SNCF ex-P.O. 2. Klasse B8t n° 47220, Ep. III-B*



VB-294

Modernisée Sud-Ouest SNCF
 3^{ème} classe/fourgon C4Dt n° 46738, Ep. III-A
 3rd class / Luggage van SNCF C4Dt n° 46738, Ep. III-A

SNCF 3. Klasse/Gepäck C4Dt n° 46738, Ep. III-A



VB-295

Modernisée Sud-Ouest SNCF
 2^{ème} classe/fourgon B4Dt n° 46735, Ep. III-B
 2nd class / Luggage van SNCF B4Dt n° 46735, Ep. III-B

2. Klasse/Gepäck B4Dt n° 46735, Ep. III-B





VB-065.1

A9 Vert celtique 301,
châssis gris Ep.IV

A9 SNCF 301 green, grey frame Ep.IV

A9, grün, Rahmen grau, Ep.IV



VB-067.1

B10 Vert celtique 301, châssis gris
Ep.IV

B10 SNCF 301 green, grey frame Ep. IV

B10, grün, Rahmen grau, Ep. IV



VB-073.1

A4B5 Vert celtique 301,
châssis gris Ep. IV

A4B5 SNCF 301 green, grey frame Ep. IV

A4B5, grün, Rahmen grau, Ep. IV



VB-069.1

B10 Vert celtique 301,
châssis gris Ep. IV

B10, C 160 Grey/Aluminium livery Ep.IV

B10, Farbgebung Grün/Silber, Ep.IV



VB-100.1

B5D, Livrée 160 Vert/Alu
Ep.IV

B5D, C 160 Grey/Aluminium livery Ep.IV

B5D, Farbgebung Grün/Silber, Ep.IV



VB-101.1

A9, Livrée 160 Vert/ALU Ep.IV

A9, C 160 Grey/Aluminium livery Ep.IV

A9, Farbgebung Grün/Silber, Ep.IV



VB-104

B10 Vert celtique 301,
châssis gris CFL - Ep.IV

B10 SNCF 301 green, grey frame CFL Ep.IV

B10, grün, Rahmen grau CFL Ep.IV



VB-103

Set de 3 Voitures UIC

B10 Vert celtique 301,
châssis gris CFL
Ep.IV

*Set of 3 UICY COACH
B10 SNCF 301 green, grey frame CFL Ep.IV*

*Set aus 3 UIC WAGEN
B10, grün, Rahmen grau CFL Ep.IV*



VB-105

Set de 3 Voitures UIC

A9 Capitole de Réserve
Livrée Rouge Ep.IV

*Set of 3 UICY COACH
A9 « Le Capitole » train spare coach,
red livery Ep.IV*

*Set aus 3 UIC WAGEN
A9, Ersatzwagen,
rote Capitole Farbgebung, Ep.IV*



VB-120

«LE CAPITOLE» A9 Rouge Plaque Le
Capitole Ep.IV - AVEC ÉCLAIRAGE

*«LE CAPITOLE» A9 Red, Le Capitole plate
Ep.IV - With lights*

*«LE CAPITOLE» A9, rot, Schild Le Capitole,
Ep.IV - Mit Beleuchtung*

VB-121

«LE CAPITOLE» A9 Rouge Plaque Le
Capitole Ep.IV - AVEC ÉCLAIRAGE

*«LE CAPITOLE» A9 Red, Le Capitole plate
Ep.IV - With lights*

*«LE CAPITOLE» A9, rot, Schild Le Capitole,
Ep.IV - Mit Beleuchtung*

VB-207

Restaurant Vru Rouge «CAPITOLE» N°17
Ep.IV - AVEC ÉCLAIRAGE (By LSM)

*Vru Restaurant Car, Red «CAPITOLE» N°17
Ep.IV - With lights (By LSM)*

*Vru Speisewagen, rot «CAPITOLE» N°17 Ep.IV
mit Beleuchtung (By LSM)*



VB-208

Restaurant Vru Rouge «CAPITOLE» N°18
Ep.IV - AVEC ÉCLAIRAGE (By LSM)

*Vru Restaurant Car, Red «CAPITOLE» N°18
Ep.IV - With lights (By LSM)*

*Vru Speisewagen, rot «CAPITOLE» N°17 Ep.IV
mit Beleuchtung (By LSM)*





VB-159

B5D Vert Garrigue / Gris Béton logo encadré, cartouche corail Ep.IV-V.

B5D « Garrigue » green / « Béton » grey, boxed SNCF logo, « cartouche corail » class signage Ep.IV-V.

B5D, grün/betongrau, weißes SNCF Zeichen, Corail Schriftzug, Ep.IV-V



VB-160

B5D Vert Garrigue / Gris Béton Logo nouille, cartouche corail Ep.V.

B5D « Garrigue » green / « Béton » grey, « nouille » SNCF logo, « cartouche corail » class signage Ep.V.

UIC WAGEN B5D, grün/betongrau, Nudel SNCF Zeichen, Corail Schriftzug, Ep.V



VB-166

A4B5 ex-A9 Vert Garrigue / Gris Béton logo nouille, cartouche corail Ep.V.

A4B5 ex-A9 « Garrigue » green / « Béton » grey « nouille » SNCF logo, « cartouche corail » class signage Ep.V.

A4B5 ex-A9, grün/betongrau, Nudel SNCF Zeichen, Corail Schriftzug, Ep.V



VB-167

A4B5 ex-A9 Vert Garrigue / Gris Béton logo casquette, cartouche corail TER Ep.V

A4B5 ex-A9 « Garrigue » green / « Béton » grey « casquette » SNCF logo, « cartouche corail » class signage, TER Ep.V.

A4B5 ex-A9, grün/betongrau, Pfeil SNCF Zeichen, Corail Schriftzug, TER Ep.V



VB-168

B10 Vert Garrigue / Gris Béton logo casquette, cartouche corail TER Ep.V

B10 « Garrigue » green / « Béton » grey, « casquette » SNCF logo, « cartouche corail » class signage, TER Ep.V.

B10, grün/betongrau, Pfeil SNCF Zeichen, Corail Schriftzug TER, Ep.V



VB-202

A4B5, Livrée 160 Vert/ALU Ep.IV

A4B5, C 160 Grey/Aluminium livery Ep.IV

A4B5, Farbgebung Grün/Silber, Ep.IV



VB-158

B5D Vert Garrigue / Gris Béton logo encadré, cartouche corail Ep.IV-V.

B5D « Garrigue » green / « Béton » grey, boxed SNCF logo, « cartouche corail » class signage B5D, grün/betongrau, weißes SNCF Zeichen, Corail Schriftzug, Ep.IV-V



VB-171.1

B9c9, Vert 301, châssis gris,
logo rond, Ep III

*B9c9, SNCF 301 green, grey frame, round
SNCF logo, Ep III*

*B9c9, grün, Rahmen grau, rundes SNCF
Zeichen, Ep III*



VB-173

B9c9, toit haut, Vert 301, châssis
gris, logo jaune encadré, Ep IV

*B9c9, SNCF 301 green, grey frame, boxed
yellow SNCF logo Ep IV*

*B9c9, grün, Rahmen grau, gelbes SNCF
Zeichen, Ep IV*

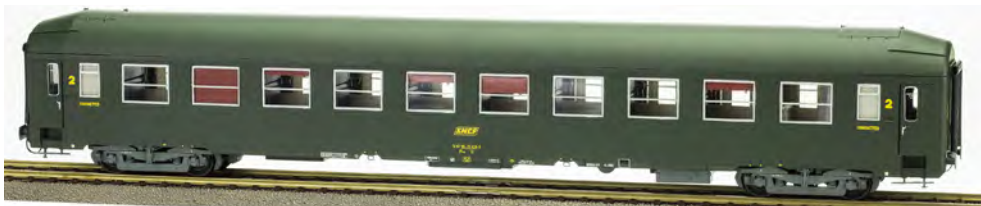

VB-175.1

B9C9 Vert 301, châssis gris,
logo jaune encadré, Ep IV

*B9c9 SNCF 301 green, grey frame, boxed
yellow SNCF logo, Ep IV*

*B9C9, grün, Rahmen grau, gelbes SNCF
Zeichen, Ep IV*



VB-178

B9C9, Vert 301, châssis gris,
logo rond Ep.III

*B9c9, SNCF 301 green, grey frame,
round SNCF logo Ep.III*

*B9C9, grün, Rahmen grau,
rundes SNCF Zeichen, Ep.III*



VB-179

Coffret 3 voitures UIC Couchettes

Toit haut, B9C9, Vert/Alu
livrée 160 Ep.IV

*Set of 3 UIC Y Couchette Cars,
B9c9 High Roof, Green/Aluminium
C160 livery Ep.IV*

*Set aus 3 UIC Liegewagen,
B9C9, Farbgebung Grün/Silber, Ep.IV*



Voiture UIC Couchettes
UIC couchette car · UIC Liegewagen



VB-180

Toit Haut, B9C9, Vert/Alu livrée 160 Ep.IV

B9c9 High Roof, Green/Aluminium C160 livery Ep.IV

B9C9, Farbgebung Grün/Silber, Ep.IV



VB-181

Coffret 3 voitures UIC Couchettes

B9C9 Bleu, logo nouvelle Ep.V

Set of 3 UIC Y Couchette Cars, B9c9, Blue, « nouvelle » SNCF logo Ep V

Set aus 3 UIC LIEGEWAGEN B9C9 Blau, Nudel SNCF Zeichen, Ep V



VB-182

B9C9 Bleu, logo nouvelle Ep.V

B9c9, Blue, « nouvelle » SNCF logo Ep V

B9C9 Blau, Nudel SNCF Zeichen, Ep V



VB-184

Toit Haut B9C9 Bleu, logo casque Ep.V

B9c9 High Roof, blue, « Casque » SNCF logo Ep V

B9C9 Blau, Pfeil SNCF Zeichen, Ep V



VB-186

Toit Haut, A4c4B5c5, Vert 301, logo jaune encadré, Ep.IV

A4c4B5c5, SNCF 301 green, boxed yellow SNCF logo Ep.IV

A4c4B5c5, grün, gelbes SNCF Zeichen Ep.IV

VB-185
Coffret 3 voitures UIC Couchettes
 2xB9C9 + 1xA4c4B5c5, Vert 301,
 Toit haut, logo jaune encadré Ep.IV

Set of 3 UIC Y Couchette Cars High Roof
 2 x B9c9 + 1 x A4c4B5c5
 SNCF 301 green,
 boxed yellow SNCF logo Ep.IV

Set aus 3 UIC Liegenwagen
 2 x B9C9 + 1 x A4c4B5c5
 grün, gelbes SNCF Zeichen, Ep.IV



VB-187
Coffret 3 voitures UIC Couchettes
 2xB9C9 + 1 x A4c4B5c5, Toit haut,
 Vert/Alu livrée 160 avec une voiture
 toit gris Ep.IV

Set of 3 UIC Y Couchette Cars High Roof,
 2 x B9C9 + 1 x A4c4B5c5
 Green/Aluminium C160 livery
 1 coach with grey roof Ep.IV

Set aus 3 UIC Liegenwagen
 2 x B9C9 + 1 x A4c4B5c5
 Farbgebung Grün/Silber davon ein
 Wagen mit grauem Dach, Ep.IV



VB-188
 A4c4B5c5, toit haut, Vert/Alu
 livrée 160 Ep.IV
 A4c4B5c5, Green/Aluminium C160 livery
 A4c4B5c5, Farbgebung Grün/Silber, Ep.IV



VB-189.1
 Toit Haut A4c4B5c5 Bleu,
 logo casque, Ep.V
 A4c4B5c5, Blue, SNCF « casque » logo Ep.V
 A4c4B5c5 Blau, Pfeil SNCF Zeichen, Ep.V



VB-190.1
 Toit Haut A4c4B5c5 Bleu,
 logo nouille Ep.V
 A4c4B5c5, Blue, SNCF « nouille » logo Ep.V
 A4c4B5c5 Blau, Nudel SNCF Zeichen, Ep.V





VB-192

Toit Haut, A4c4B5c5 Bleu,
Logo casque Ep V

A4c4B5c5, Blue, SNCF « casque » logo Ep.V
A4c4B5c5 Bleu, Pfeil SNCF Zeichen, Ep.IV



VB-221

Coffret 3 voitures UIC Couchettes

Toit Haut,
2xB9C9 + 1x A4c4B5c5,
Vert/Alu livrée 160 Ep.IV

Set of 3 UIC Y Couchette Cars High Roof,
2 x B9C9 + 1 x A4c4B5c5
Green/Aluminium C160 livery Ep.IV



Set aus 3 UIC Liegenwagen
2 x B9C9 + 1 x A4c4B5c5
Farbgebung Grün/Silber, Ep.IV



VB-222

Toit Haut, B9C9,
Vert/Alu livrée 160 Ep.IV

B9c9 High Roof, Green/Aluminium C160
livery Ep.IV

B9C9, Farbgebung Grün/Silber, Ep.IV



VB-223

Toit Haut, A4c4B5c5,
Vert/Alu livrée 160 Ep.IV

A4c4B5c5, Green/Aluminium C160 livery

A4c4B5c5, Farbgebung Grün/Silber, Ep.IV



VB-225

Toit Haut, B9C9, Vert 301,
Logo jaune encadré Ep.IV

B9c9 High roof, SNCF 301 green, boxed
yellow SNCF logo Ep.IV

B9C9, grün, gelbes SNCF Zeichen Ep.IV

Voiture UIC Couchettes
UIC couchette car · UIC Liegenwagen

VB-224
Coffret 3 voitures UIC Couchettes
 Toit Haut, 2x B9C9 + 1x A4c4B5c5
 Vert 301, logo jaune encadré Ep.IV

*Set of 3 UIC Y Couchette Cars High Roof
 2 x B9c9 + 1 x A4c4B5c5
 SNCF 301 green
 boxed yellow SNCF logo Ep.IV*

*Set aus 3 UIC Liegewagen
 2 x B9C9 + 1 x A4c4B5c5
 grün, gelbes SNCF Zeichen, Ep.IV*



VB-226
 Toit Haut A4C4 Verte
 logo jaune encadré Ep IV

*A4c4 green, boxed yellow SNCF logo Ep.IV
 A4c4 grün, gelbes SNCF Zeichen, Ep.IV*



VB-227
Coffret 3 voitures UIC Couchettes
 B9C9 Bleu, toit haut,
 logo casque Ep V

*Set of 3 UIC Y Couchette Cars,
 B9c9 blue, « Casque » SNCF logo Ep.V*

*Set aus 3 UIC Liegewagen B9C9 Blau
 Pfeil SNCF Zeichen, Ep.V*



VB-228
 Toit Haut B9C9 Bleu
 logo casque Ep V

B9c9 blue, « Casque » SNCF logo Ep.V

B9C9 Blau, Pfeil SNCF Zeichen Ep.V



VB-229
 Toit Haut B9C9 Bleu
 logo casque Ep V

*A4c4B5c5, Blue,
 SNCF « casque » logo Ep V*

A4c4B5c5 Blau, Pfeil SNCF Zeichen, Ep V





WB-227

«SEGI» HM 524341
Remorque «Paris-Aquitaine» bâché simple essieu Ep.III

«SEGI» HM 524341 + Tarpaulin trailer «Paris-Aquitaine» single axle Ep.III

«SEGI» HM 524341 + Auflieger «Paris-Aquitaine» Plane 1-achsige Ep.III



WB-228

«SEGI» HM 524339
+ Remorque «MOBYLETTE» tôlé simple essieu Ep.III

«SEGI» HM 524339 + Panel trailer «MOBYLETTE» single axle Ep.III

«SEGI» HM 524339 + Auflieger «MOBYLETTE» verblecht 1-achsige Ep.III



WB-230

«SEGI» HM 524357
Ep.III vide

«SEGI» HM 524357 Ep.III empty

«SEGI» HM 524357 Ep.III leer



WB-231

«ALGECO» HM 5501381
Ep.III-IV vide

«ALGECO» HM 5501381 ALGECO empty

«ALGECO» HM 5501381 ALGECO leer



WB-232

«SEGI» HM 524355 Ep.III vide
Fin de convoi et 1 seul attelage

«SEGI» HM 524355 Ep.III empty (End of train - 1 coupler only)

«SEGI» HM 524355 Ep.III leer (Zugschluss - 1 einzige Kupplung)



WB-233

«SEGI» 20 87 040 0 364-8 Ep.IV vide
Fin de Convoi et 1 seul attelage

«SEGI» 20 87 040 0 364-8 Ep.IV empty (End of train - 1 coupler only)

«SEGI» 20 87 040 0 364-8 Ep.IV leer (Zugschluss - 1 einzige Kupplung)

WB-339.1

«SEGI» N° 20 87 040 0 376-2
+ Remorque «RENAULT» tôlé simple
essieu Ep.III-IV

«SEGI» N° 20 87 040 0 376-2
+ Panel trailer «RENAULT» single axle Ep.III-IV

«SEGI» N° 20 87 040 0 376-2+ Auffieger
«RENAULT» verblecht 1-achsig Ep.III-IV



WB-355

Rampe de Chargement KANGOUROU
Ep.III

Loading ramp KANGOUROU Ep.III

Verladebühne KANGOUROU Ep.III



WB-356

Rampe de Chargement KANGOUROU
Ep.IV

Loading ramp KANGOUROU Ep.IV

Verladebühne KANGOUROU Ep.IV



FB-007- Set de 3 remorques Ep.III - «ORANGE et VERTE Renault» bâché simple essieu, «BERARD» bâché double essieux, «CORDIER» bâché double essieux.

SET of 3 Kangourou trailers Ep.III, «ORANGE and GREEN Renault» tarpaulin single axle, «BERARD» tarpaulin twin axle, «CORDIER» tarpaulin twin axle

Set aus 3 Auffieger Kangourou Ep.III, «ORANGE et VERTE Renault» Plane 1-achsig, «BERARD» Plane 2-achsig, «CORDIER» Plane 2-achsig



CB-062- Tracteur Kangourou Vert
N°210 Ep.III

Kangourou Tractor unit Green N°210 Ep.III
Zugmaschine Kangourou Grün N°210 Ep.III



CB-063- Tracteur Kangourou Vert
N°210 Ep.IV

Kangourou Tractor unit Green N°210 Ep.IV
Zugmaschine Kangourou Grün N°210 Ep.IV

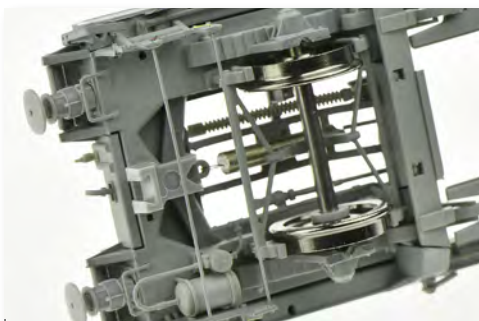



WB-367

SET de 2 wagons Coke ARBEL

3 Portes Caisse ronde "ARBEL UPWS" et Caisse pans coupés "ARBEL TRANORD" Ep.III

Set of 2 Coke transport Wagons ARBEL 3 Doors Rounded body "ARBEL UPWS" and Cut-off body "ARBEL TRANORD" Ep.III

Set aus 2 Kokswagen ARBEL 3 Türen Runder Kasten "ARBEL UPWS" und abgeschrägter Kasten "ARBEL TRANORD" Ep.III



WB-368 - 3 Portes Caisse pans coupés "ARBEL" Ep.III
ARBEL 3 Doors Cut-off body "ARBEL" Ep.III
ARBEL 3 Türen abgeschrägter Kasten "ARBEL" Ep.III



WB-369 - 3 Portes Caisse pans coupés "HBNPC" Ep.III
3 Doors Cut-off body "HBNPC" Ep.III
3 Türen abgeschrägter Kasten "HBNPC" Ep.III



WB-372

SET de 2 Wagons Coke MH45

3 essieux boîtes Diathermix "SCRC" roues Léonard "STEMI" Ep.III

3 axes Diathermix bearings "SCRC", Léonard Wheels "STEMI" Ep.III

3-achsig Achslager Diathermix "SCRC" Räder Léonard "STEMI" Ep.III



WB-373

SET de 2 Wagons Coke MH45

3 essieux boîtes Diathermix "SIMOTRA" roues Léonard Ep.III

3 axes Diathermix "SIMOTRA" Léonard Wheels Ep.III

3-achsig Achslager Diathermix "SIMOTRA" Räder Léonard Ep.III



WB-374 - 3 essieux boîtes Diathermix "C^{ie} du MIDI" 4 roues Léonard Ep.III
3 axes Diathermix "C^{ie} du MIDI" 4 roues Léonard Ep.III
3-achsig Achslager Diathermix "C^{ie} du MIDI" 4 Räder Léonard Ep.III



WB-375 - 3 essieux boîtes Diathermix "CRFF" 4 roues Léonard Ep.III
3 axes Diathermix "CRFF" 4 Léonard Wheels Ep.III
3-achsig Achslager Diathermix "CRFF" 4 Räder Léonard Ep.III



WB-377 - 3 essieux boîtes à rouleaux "STEMI" Ep.IV
3 axes roller bearings "STEMI" Ep.IV
3-achsig Rollenachslager "STEMI" Ep.IV

WB-378

Set de 2 wagons Coke ex-MH45
2 essieux boîtes à rouleaux "STEMI"
Ep.IV
Set of 2 Coke transport Wagons ex-MH45
2 axes roller bearings "STEMI" Ep.IV
Set aus 2 Kokswagen ehem. MH45
2-achsig Rollenachslager "STEMI" Ep.IV



WB-379

Set de 2 wagons Coke ex-MH45
2 essieux boîtes à rouleaux "STEMI"
Ep.IV
Set of 2 Coke transport Wagons ex-MH45
2 axes roller bearings "STEMI" Ep.IV
Set aus 2 Kokswagen ehem. MH45
2-achsig Rollenachslager "STEMI" Ep.IV







WB-456

SET de 2 Wagons Citernes

Cuve lisse, N° 547149 et 547150
'ALGECO BP' et Ep.III SNCF avec
Plaque Métal BP

*Set of 2 Tank Wagons welded tank,
N° 547149 et 547150 'ALGECO BP' and
Ep.III SNCF with BP metal plate*

*Set aus 2 Kesselwagen glatter Kessel,
N° 547149 und 547150 'ALGECO BP' und
Ep.III SNCF mit Metallschild BP*



WB-453 - Wagon réservoir cuve rivetée, guérite
serre-freins «SIMOTRA» n°584639 - Ep.II PLM
*Riveted tank Brakeman's cab 'SIMOTRA' N°584639 Ep.II PLM
Genieteter Kessel, Bremserhaus 'SIMOTRA' N°584639 Ep.II PLM*



WB-459 - Cuve lisse, freiné, 'DUQUESNE PURINA'
N° 21870775273-7 Ep.IV SNCF
*Welded tank, with brakes, 'DUQUESNE PURINA' Ep.IV SNCF
Glatter Kessel, gebremst, 'DUQUESNE PURINA' Ep.IV SNCF*



WB-460 - Cuve lisse, plateforme serre-freins,
'St-RAPHAËL' N° 21870727957-4 Ep.IV SNCF
*Welded tank, Brakeman's platform, 'St-RAPHAËL' Ep.IV SNCF
Glatter Kessel, Bremserbühne, 'St-RAPHAËL' Ep.IV SNCF*



WB-461 - Cuve lisse, plateforme serre-freins,
'VIN DES ROCHERS' N° 21870715357-1 Ep.IV SNCF
*Welded tank, Brakeman's platform, 'VIN DES ROCHERS' Ep.IV SNCF
Glatter Kessel, Bremserbühne, 'VIN DES ROCHERS' Ep.IV SNCF*



WB-467 - Wagon Citerne OCEM 19 Citerne rivetée,
'LE ROI GRAP' N°584531 Ep.III SNCF

OCEM 19 Tank Wagon, riveted tank, 'LE ROI GRAP' Ep.III SNCF

Kesselwagen OCEM 19 genieteter Kessel, 'LE ROI GRAP' Ep.III SNCF

Wagons citerne OCEM
Tank wagon · Kesselwagen



WB-495

SET de 3 citernes ANF longues

Bogie Y 23M N°21 87 007 1 339-2,
N°21 87 007 1 341-8 et
N° 21 87 007 1 346-7 «ELF» Ep.IV

*Set of 3 ANF long tank wagons,
Y23M bogie
N°21 87 007 1 339-2,
N°21 87 007 1 341-8
and N° 21 87 007 1 346-7 «ELF» Ep.IV*

*Set mit 3 ANF Kesselwagen, lang,
Y23M Drehgestelle,
N°21 87 007 1 339-2,
N°21 87 007 1 341-8
und N° 21 87 007 1 346-7 «ELF» Ep.IV*



WB-496

SET de 3 citernes ANF longues

bogie Y 23M, n°33 87 7851429-3,
n°33 87 7851423-6 et
n°33 87 7851430-1
«ESSENCE DES ARMEES» Ep.IV-V

*SET of 3 ANF long tank wagons,
Y23M bogie,
n°33 87 7851429-3, 33 87 7851423-6
and 33 87 7851430-1
«ESSENCE DES ARMEES» Ep.IV-V*

*Set mit 3 ANF Kesselwagen, lang,
Y23M Drehgestelle,
N°33 87 7851429-3, 33 87 7851423-6
und 33 87 7851430-1
«ESSENCE DES ARMEES» Ep.IV-V*



Ces wagons construits en 1905 ont tous des boîtes d'essieux type PLM.
These wagons built in 1905 are fitting PLM typ bearings.
Diese 1905 gebauten Güterwagen besitzen alle Achslager vom Typ PLM.

WB-437

SET de 2 Wagons plats

ex-PLM, freiné,
N° Jo115079 et N° Jo116352
SNCF Ep.III

*Set of 2 flat Wagons ex-PLM, with brakes,
N° Jo115079 and N° Jo116352 SNCF Ep.III*

*Set aus 2 Flachwagen ex-PLM, gebremst,
N° Jo115079 und N° Jo116352 SNCF Ep.III*



WB-440

Ex-PLM freiné avec frein à levier
n° Jo113508 SNCF Ep.III

*ex-PLM, with handbrake,
N° Jo113508 SNCF Ep.III*

*ex-PLM gebremst mit Hebelbremse
N° Jo113508 SNCF Ep.III*



WB-442

Ex-PLM freiné avec frein à levier
n° IP999518 MT SNCF Ep.III

*ex-PLM, with handbrake,
n°IP999518 MT SNCF Ep.III*

*ex-PLM gebremst mit Hebelbremse
n° IP999518 MT SNCF Ep.III*



WB-443

Ex-PLM avec frein à levier N°
Jo996362 VB SNCF Ep.III

*ex-PLM, with handbrake,
n° Jo996362 VB SNCF Ep.III*

*ex-PLM mit Hebelbremse
n° Jo996362 VB SNCF Ep.III*



Wagons plats PLM
Flat wagon · Flachwagen



WB-400

PLAT TP à 6 ridelles non freiné Ep.III
DB N° 499283 XXto

TP Flat 6 side walls Wagon without brakes Ep.III DB N° 499283 XXto
TP Flachwagen mit 6 Bordwänden ungebremst Ep.III DB N° 499283 XXto



WB-401

PLAT TP à 6 ridelles non freiné Ep.III
DB N° 498976 XXto

TP Flat 6 side walls Wagon without brakes Ep.III DB N° 498976 XXto
TP Flachwagen mit 6 Bordwänden ungebremst Ep.III DB N° 498976 XXto



VB-402

PLAT TP à 6 ridelles Ep.III CFL
N° NTyw 32-91559

TP Flat 6 side walls Wagon Ep.III CFL N° NTyw 32-91559
TP Flachwagen mit 6 Bordwänden Ep.III CFL N° NTyw 32-91559



WB-403

PLAT TP à 6 ridelles Ep.III CFL
N° NTyw 44152

TP Flat 6 side walls Wagon Ep.III CFL N° NTyw 44152
TP Flachwagen mit 6 Bordwänden Ep.III CFL N° NTyw 44152



WB-429

PLAT TP à 6 ridelles Ep.IV SNCF
N° 20 87 388 5 718-3

TP Flat 6 side walls Wagon Ep.IV SNCF N° 20 87 388 5 718-3
TP Flachwagen mit 6 Bordwänden Ep.IV SNCF N° 20 87 388 5 718-3



WB-497

PLAT TP à 5 ridelles Ep.II ETAT
NTyw 136318

TP Flat 5 side walls Wagon Ep.II ETAT NTyw 136318
TP Flachwagen mit 5 Bordwänden Ep.II ETAT NTyw 136318



WB-498

PLAT TP à 5 ridelles Ep.II PO
NTyw 110525

TP Flat 5 side walls Wagon Ep.II PO NTyw 110525
TP Flachwagen mit 5 Bordwänden Ep.II PO NTyw 110525



WB-500

PLAT TP Ep.II EST Ryw 96531

TP Flat Wagon Ep.II EST Ryw 96531
TP Flachwagen Ep.II EST Ryw 96531



WB-501

PLAT TP sans commande de freins Ep.II
PLM USA 83969

TP Flat Wagon without brake control Ep.II PLM USA 83969
TP Flachwagen ohne Bremsen Ep.II PLM USA 83969

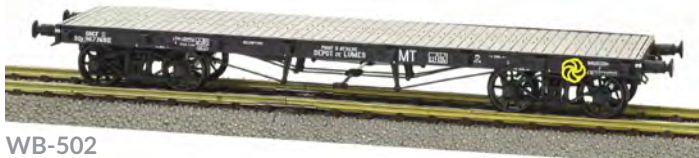

WB-502

PLAT TP sans freins, 4 roues à rayons
Ep.III B SNCF "MT" SQy 967369

TP Flat Wagon without brakes, 4 spoked wheels Ep.III B SNCF "MT" SQy 967369
TP Flachwagen ungebremst, 4 Speichenräder Ep.III B SNCF "MT" SQy 967369



WB-503

PLAT TP Ep.III B SNCF Qrywv 175236

TP Flat Wagon Ep.III B SNCF Qrywv 175236
TP Flachwagen Ep.III B SNCF Qrywv 175236



WB-505

Ranchers hauts avec Guérite Ep.III B

SNCF Qrywf 180471

TP Flat Wagon high stacks with Brakeman's cab Ep.III B SNCF Qrywf 180471
TP Flachwagen Rungen lang mit Bremserhaus Ep.III B SNCF Qrywf 180471



WB-506

PLAT TP ranchers hauts avec Guérite

Ep.IV SNCF 30 87-972 1 482-9

TP Flat Wagon high stacks with Brakeman's cab Ep.IV SNCF
TP Flachwagen Rungen lang mit Bremserhaus Ep.IV SNCF

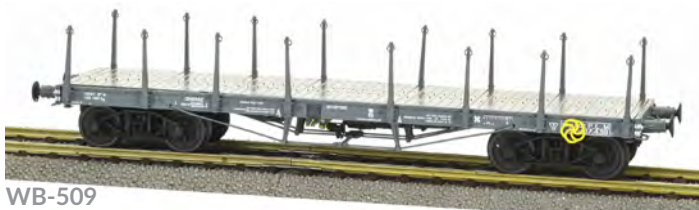

WB-509

PLAT TP ranchers longs Ep.II PLM

Ryw 37439

TP Flat Wagon long stacks Ep.II PLM Ryw 37439
TP Flachwagen Rungen lang Ep.II PLM Ryw 37439



WB-510

PLAT TP ranchers courts Ep.II

PLM Ryw 37025

TP Flat Wagon short stacks Ep.II PLM Ryw 37025
TP Flachwagen Rungen kurz Ep.II PLM Ryw 37025



WB-511

PLAT TP ranchers courts Ep.II NORD

Ryw 15039

TP Flat Wagon short stacks Ep.II NORD Ryw 15039
TP Flachwagen Rungen kurz Ep.II NORD Ryw 15039

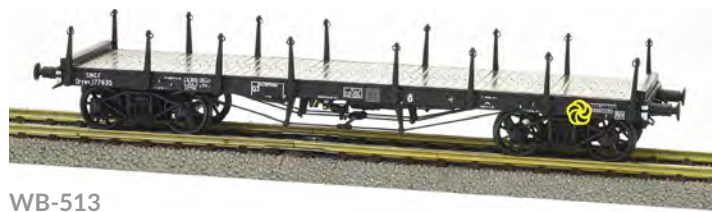

WB-513

PLAT TP ranchers courts Ep.III B

SNCF Qrywv 177835

TP Flat Wagon short stacks Ep.III B SNCF Qrywv 177835
TP Flachwagen Rungen kurz Ep.III B SNCF Qrywv 177835



WB-514

PLAT TP ranchers longs Ep.III B

SNCF Qrywv 181256

TP Flat Wagon long stacks Ep.III B SNCF Qrywv 181256
TP Flachwagen Rungen lang Ep.III B SNCF Qrywv 181256

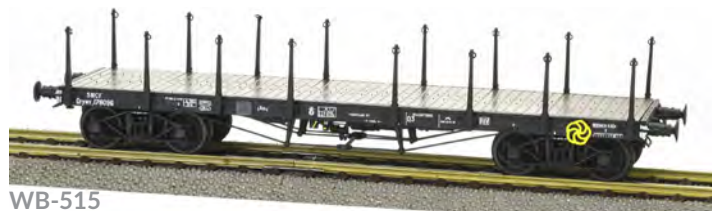

WB-515

PLAT TP ranchers longs Ep.III B

SNCF Qrywv 178096

TP Flat Wagon long stacks Ep.III B SNCF Qrywv 178096
TP Flachwagen Rungen lang Ep.III B SNCF Qrywv 178096



WB-516

PLAT TP ranchers longs Ep.IV

SNCF N°21 87 387 8 211-7

TP Flat Wagon long stacks Ep.IV SNCF N°21 87 387 8 211-7
TP Flachwagen Rungen lang Ep.IV SNCF N°21 87 387 8 211-7



WB-518
COUVERT TP 2 Portes Ep.II PLM Kwy 113019
TP covered Wagon 2 Doors Ep.II PLM Kwy 113019
TP Gedeckter Güterwagen 2. Türig Ep.II PLM Kwy 113019



WB-521
COUVERT TP 2 Portes Ep.III A SNCF Kwy 113048
TP covered Wagon 2 Doors Ep.III A SNCF Kwy 113048
TP Gedeckter Güterwagen 2. Türig Ep.III A SNCF Kwy 113048



WB-522
COUVERT TP 2 Portes Ep.III A SNCF Kwy 379803
TP covered Wagon 2 Doors Ep.III A SNCF Kwy 379803
TP Gedeckter Güterwagen 2. Türig Ep.III A SNCF Kwy 379803



WB-523
COUVERT TP 2 Portes Ep.III A SNCF Lyw 417826
TP covered Wagon 2 Doors Ep.III A SNCF Lyw 417826
TP Gedeckter Güterwagen 2. Türig Ep.III A SNCF Lyw 417826



WB-524
COUVERT TP 2 Portes Ep.III B SNCF Lyw 416919
TP covered Wagon 2 Doors Ep.III B SNCF Lyw 416919
TP Gedeckter Güterwagen 2. Türig Ep.III B SNCF Lyw 416919



WB-525
COUVERT TP 2 Portes Ep.III B SNCF Lyw 418305
TP covered Wagon 2 Doors Ep.III B SNCF Lyw 418305
TP Gedeckter Güterwagen 2. Türig Ep.III B SNCF Lyw 418305



WB-528
COUVERT TP 2 Portes Ep.III DR 15-11-54
TP covered Wagon 2 Doors Ep.III DR 15-11-54
TP Gedeckter Güterwagen 2. Türig Ep.III DR 15-11-54



WB-529
TP FRIGO Origine PO ex-USA Ep.II
TP Refrigerated Wagon original condition PO ex-USA Ep.II
TP Kühlwagen Ursprungsausführung PO ex-USA Ep.II



WB-532
TP FRIGO Origine PLM Ep.II
TP Refrigerated Wagon original condition PO Ep.II
TP Kühlwagen Ursprungsausführung PO Ep.II



WB-536
TP FRIGO Origine à trappes à glace SNCF Ep.III
TP Refrigerated Wagon original condition with Ice filling trapdoors SNCF Ep.III
TP Kühlwagen Ursprungsausführung mit Eisluken SNCF Ep.III



WB-538
TP FRIGO Origine à trappes à glace et aérateurs SNCF Ep.III
Original condition with Ice filling trapdoors and ventilators SNCF Ep.III
Ursprungsausführung mit Eisluken und Lüfter SNCF Ep.III



WB-539
TP FRIGO Origine à trappes à glace et aérateurs SNCF Ep.III
Original condition With Ice filling trapdoors and ventilators SNCF Ep.III
Ursprungsausführung mit Eisluken und Lüfter SNCF Ep.III



WB-540
TP FRIGO Origine à trappes à glace DR-USSR Zone Ep.III
Original condition With Ice filling trapdoors DR-USSR Zone Ep.III
Ursprungsausführung mit Eisluken DR-UdSSR Zone Ep.III

TP Frigos
TP refrigerated wagons · TP Kühlwagen



La série 2 des wagons TP isothermes se compose de wagons d'anciennes compagnies et aussi de wagons reconstruits qui ont roulé jusqu'au milieu des années 60.

The series 2 of TP refrigerated wagons includes pre-SNCF companies wagons and also some rebuilt wagons operating until mid sixties.

Die 2. Serie des TP Kühlwagen setzt sich aus Wagen der alten Eisenbahn Verwaltungen sowie Rekonstruktionswagen zusammen, die bis Mitte der 1960er Jahre liefen.



WB-577 - Origine ETAT Ep.II
TP refrigerated Wagon Original condition ETAT Ep.II
TP Kühlwagen Ursprungsausführung ETAT Ep.II



WB-578 - Origine PLM STEF Ep.II
TP refrigerated Wagon Original condition PLM Ep.II
TP Kühlwagen Ursprungsausführung PLM Ep.II



WB-579 - Origine à trappes à glace PLM STEF Ep.II (avec essieux Griffin)
Original condition with Ice filling Trapdoors PLM STEF Ep.II (with Griffon axles)
Ursprungsausführung mit Eisluken PLM STEF Ep.II (mit Griffin Achsen)



WB-580 - Origine, SNCF STEF Ep.III
Original condition, SNCF STEF Ep.III
Ursprungsausführung, SNCF STEF Ep.III



WB-582 - Reconstituit, trappes à glace SNCF STEF Ep.III
Rebuilt with Ice filling Trapdoors SNCF STEF Ep.III
Rekonstruktion, Eisluken SNCF STEF Ep.III



WB-583 - Reconstituit, trappes à glace SNCF STEF lettres Bleues Ep.III
Rebuilt with Ice filling Trapdoors SNCF STEF blue lettering Ep.III
Rekonstruktion, Eisluken SNCF STEF blaue Anschrift Ep.III



WB-584 - Reconstituit, Trappes à glace et Aérateurs SNCF STEF lettres Bleues Ep.III
Rebuilt with Ice filling Trapdoors and ventilators SNCF STEF blue lettering Ep.III
Rekonstruktion, Eisluken und Lüfter SNCF STEF blaue Anschrift Ep.III



WB-585 - Reconstituit, Trappes à glace et Aérateurs SNCF STEF lettres Bleues Ep.III
Rebuilt with Ice filling Trapdoors and ventilators SNCF STEF blue lettering Ep.III
Rekonstruktion, Eisluken und Lüfter SNCF STEF blaue Anschrift Ep.III



WB-581
Coffret de 3 TP Frigo
Origine (avec ou sans trappe à glace)
SNCF STEF Ep.III

Set of 3 TP rebuilt Wagons (with or without Ice filling Trapdoors) SNCF STEF Ep.III

Set aus 3 TP Kühlwagen Ursprungsausführung (Mit und ohne Eisluken) SNCF STEF Ep.III



WB-586
Coffret de 3 TP Frigo
Reconstruit, trappes à glace
aérateurs SNCF STEF lettres Bleues Ep.III

Set of 3 rebuilt TP, Ice filling trapdoors / ventilators SNCF STEF blue lettering Ep.III

Set aus 3 TP Kühlwagen Rekonstruktion, Eisluken / Lüfter SNCF STEF blaue Anschrift Ep.III

WB-587
Coffret de 3 TP Frigo
Reconstruit, trappes à glace
Aérateurs SNCF STEF lettres Bleues Ep.III

Set of 3 refrigerated rebuilt Wagon, Ice filling Trapdoors / ventilators SNCF STEF blue lettering Ep.III

Set aus 3 Wagons TP Kühlwagen Rekonstruktion, Eisluken / Lüfter SNCF STEF blaue Anschrift Ep.III





WB-552 - Set de 2 wagons CTC Ep.III ESMERY-CARON et MAGASIN RURAUX DE L'OUEST
Set of 2 Hopper wagons CTC Ep.III ESMERY-CARON and MAGASIN RURAUX DE L'OUEST
Set aus 2 Wagen CTC Ep.III ESMERY-CARON und MAGASIN RURAUX DE L'OUEST



WB-553 - CTC Ep.III ESMERY-CARON
CTC Ep.III ESMERY-CARON
CTC Ep.III ESMERY-CARON



WB-554 - CTC Ep.III MAGASIN RURAUX DE L'OUEST
CTC Ep.III MAGASIN RURAUX DE L'OUEST
CTC Ep.III MAGASIN RURAUX DE L'OUEST



VB-555 - Set de 2 wagons Ep.III COOPERATIVE AGRICOLE DE L'ADOUR
Set of 2 Hopper wagons CTC Ep.III COOPERATIVE AGRICOLE DE L'ADOUR
Set aus 2 Wagen CTC Ep.III COOPERATIVE AGRICOLE DE L'ADOUR



WB-556 - Ep.III COOPERATIVE DE CEREALES DES LANDES
Ep.III COOPERATIVE DE CEREALES DES LANDES
Ep.III COOPERATIVE DE CEREALES DES LANDES



WB-558 - Ep.IV SANDERS
Ep. IV SANDERS
Ep. IV SANDERS



WB-557 - Set de 2 wagons Ep.IV SANDERS

*Set de of 2 Hopper wagons Ep.IV SANDERS
Set aus 2 Wagen Ep.IV SANDERS*



WB-559 - Set de 2 wagons Ep.IV TRANSCÉREALES CTC et MRO

*Set de of 2 Hopper wagons Ep.IV TRANSCÉREALES CTC and MRO
Set aus 2 Wagen Ep.IV TRANSCÉREALES CTC und MRO*



WB-560 - Ep.IV TRANSCÉREALES CTC

*Ep.IV TRANSCÉREALES CTC
Ep.IV TRANSCÉREALES CTC*



WB-561 - Ep.IV TRANSCÉREALES MRO

*Ep.IV TRANSCÉREALES MRO
Ep.IV TRANSCÉREALES MRO*



WB-623

Set de 2 wagons céréaliers

« CTC Esmery Caron et M.R.O », Aluminium, Ep.III

Set of 2 hopper wagons « CTC Esmery Caron et M.R.O », Aluminium, Ep.III

Set aus 2 Getreidewagen « CTC Esmery Caron et M.R.O », Aluminium, Ep.III



WB-624 - « CTC COTRAM », Aluminium, Ep.III

« CTC COTRAM », Aluminium, Ep.III
« CTC COTRAM », Aluminium, Ep.III

WB-625 - « CTC », gris Ep.III

« CTC », grey Ep.III
« CTC », grau Ep.III



WB-626 - « CTC », gris Ep.III

« CTC », grey Ep.III
« CTC », grau Ep.III

WB-627 - « PIONEER Coopérative de Saint-Palais », Ep.III

« PIONEER Coopérative de Saint-Palais », Ep.III
« PIONEER Coopérative de Saint-Palais », Ep.III



WB-628 - « SANDERS » (ancien logo), Ep.III

« SANDERS » (old logo), Ep.III
« SANDERS » (altes Logo), Ep.III

WB-629 - « SANDERS » (ancien logo), Ep.III

« SANDERS » (old logo), Ep.III
« SANDERS » (altes Logo), Ep.III



WB-630

Set de 2 wagons céréaliers
« UFAC Moulin Du Bos », vert
Ep.IV

Set of 2 wagons « UFAC Moulin Du Bos », green Ep.IV

Set aus 2 Wagen « UFAC Moulin Du Bos », grün Ep.IV



WB-632

Set de 2 wagons céréaliers
« MONFER » Ep.IV

Set of 2 wagons « MONFER », grey Ep.IV

Set aus 2 Wagen « MONFER », grau Ep.IV



WB-631 - « STORIONE », noir Ep.IV
« STORIONE », grey Ep.IV
« STORIONE », grau Ep.IV



WB-633 - « MONFER », gris Ep.IV
« MONFER », grey Ep.IV
« MONFER », grau Ep.IV





REE
MODELES
La différence...



WB-478 - Type B Tôlé, guérite, roues à rayons
N° 278520 Ep.II – PLM

*OCEM 29 GONDOLA CAR B Typ Panel, lookout box, spoked wheels
N° 278520 Ep.II – PLM*

*OCEM 29 Hochbordwagen Typ B, Blechwand, Bremserhaus, Speichenräder,
N° 278520 Ep.II – PLM*



WB-479 - Set de 2 Wagons **TOMBREAU OCEM 29** Type A Tôlé, plateforme, roues pleines
N° 782629 et Type B Tôlé, freiné, roues à rayons N° 748220 Ep.III

Set of 2 cars A Typ Panel, platform, disc wheels N° 782629 et B Typ Panel, with brakes, spoked wheels N° 748220 Ep.III

Set aus 2 wagen, Typ A, Blechwand, Bremserbühne, Scheibenräder, N° 782629 und Typ B, Blechwand, gebremst, Speichenräder, N° 748220 Ep.III



WB-480 - Set de 6 Wagons **TOMBREAU OCEM 29** Ep.III - Type B Tôlé, non freiné, roues pleines N° 751329, Type B Tôlé, guérite, roues à rayons N° 782727, Type B Tôlé, freiné, roues à rayons N° 748339, Type A Tôlé, plateforme, roues pleines N° 782645 Type A bois, frein à levier, roues à rayons N° 748032, Type A bois, frein à levier, roues à rayons N° 747843

Set of 6 OCEM 29 GONDOLA CARS Ep.III, B typ Panel, without brakes, disc wheels N° 751329, B typ Panel, lookout box, spoked wheels N° 782727, B typ Panel, with brakes, spoked wheels N° 748339, A typ Panel, platform, disc wheels N° 782645, A typ wooden, handbrake, spoked wheels N° 748032, Type A wooden, handbrake spoked wheels N° 747843

Set aus 6 OCEM 29 Hochbordwagen Ep.III, Typ B, Blechwand, ungebremst, Scheibenräder N° 751329, Typ B, Blechwand, Bremserhaus, Speichenräder N° 782727, Typ B, Blechwand, gebremst, Speichenräder N° 748339, Typ A, Blechwand, Bremserbühne, Scheibenräder N° 782645, Typ A, Holzwand, Hebelbremse, Speichenräder N° 748032, Typ A, Holzwand, Hebelbremse, Speichenräder N° 747843

Tombreaux OCEM

OCEM 29 Gondola Cars · OCEM 29 Hochbordwagen



WB-481 - Set de 2 Wagons TOMBEREAU OCEM 29 Type B Tôlé, non freiné, roues pleines
N° 750577 et Type A bois, frein à levier, roues à rayons N° 748007 Ep.III

Set of 2 cars A Typ Panel, platform, disc wheels N° 782629 et B Typ Panel, with brakes, spoked wheels N° 748220 Ep.III

Zweier-set aus 2 wagen Typ A, Blechwand, Bremserbühne, Scheibenräder, N° 782629 und Typ B, Blechwand, gebremst, Speichenräder, N° 748220

WB-482 - Type B Tôlé, guérite, roues à rayons N° 783602 Ep.III

OCEM 29 GONDOLA CAR B Typ Panel, lookout box, spoked wheels N° 783602 Ep.III

OCEM 29 Hochbordwagen Typ B, Blechwand, Bremsenhaus, Speichenräder, N° 783602 Ep.III



WB-483 - Type A Tôlé, plateforme, freiné, roues pleines N° 782656 Ep.III

OCEM 29 GONDOLA CAR A Typ Panel, platform, with brakes, disc wheels N° 782656 Ep.III

OCEM 29 Hochbordwagen Typ A, Blechwand, Bremserbühne, Gebremst, Scheibenräder, N° 782656 Ep.III



WB-484 - Type B Tôlé, freiné, roues à rayons N° 748453 Ep.III

OCEM 29 GONDOLA CAR B Typ Panel, with brakes, spoked wheels N° 748453 Ep.III

OCEM 29 Hochbordwagen Typ B, Blechwand, gebremst, Speichenräder, N° 748453 Ep.III



Tomberaux OCEM
OCEM 29 Gondola Cars · OCEM 29 Hochbordwagen



Set of 2 Trolleys for Draisine (Flat with racks + Gondola) Ep.III-IV
Set aus 2 Draisine Beiwagen (Flach mit Rungen + Hochbord) Ep.III-IV

WB-485
SET de 2 Wagonnets de Draisine
Plat à ranchers + Tombereau
Ep.III-IV
(RETIRAGE)



Set of 2 Trolleys for Draisine (Flat with racks and rails + Gondola with brakeman's cab) Ep.III-IV
Set aus 2 Draisine Beiwagen (Niederbord und Rungen + Hochbord mit Bremserhaus) Ep.III-IV

WB-486
SET de 2 Wagonnets de Draisine
Plat à ridelles et ranchers
+ Tombereau avec guérite
Ep.IV-V
(RETIRAGE)



Set of 2 Trolleys for Draisine (Flat with racks + Gondola) Ep.IV-V
Set aus 2 Draisine Beiwagen (Flach mit Rungen + Hochbord) Ep.IV-V

WB-489
SET de 2 Wagonnets de Draisine
Plat à ranchers + Tombereau
Ep.III-IV
(RETIRAGE)



Set of 2 Trolleys for Draisine (Flat with racks and rails + Flat with racks and end rails) Ep.IV-V
Set aus 2 Draisine Beiwagen (Niederbord und Rungen + Flach mit Rungen und Stimmwand) Ep.IV-V

WB-492
SET de 2 Wagonnets de Draisine
Plat à ridelles et ranchers
+ Plat à ranchers et bouts ridelles
Ep.III-IV
(RETIRAGE)



WB-562
Plat à ranchers et bouts ridelles
Ep.III-IV
NOUVELLE RÉFÉRENCE



Trolley for Draisine (Flat with racks and end rails) Ep.III-IV
Draisine Beiwagen (Flach mit Rungen und Stirnwand) Ep.III-IV

WB-563
Plat à ranchers
Ep.III-IV
NOUVELLE RÉFÉRENCE



Trolleys for Draisine (Flat with racks) Ep.III-IV
Draisine Beiwagen (Flach mit Rungen) Ep.III-IV

WB-564
Tombereau
Ep.III-IV
NOUVELLE RÉFÉRENCE



Trolleys for Draisine (Gondola) Ep.III-IV
Draisine Beiwagen (Hochbord) Ep.III-IV

WB-565
Tombereau à guérite Ep.III-IV
NOUVELLE RÉFÉRENCE



Trolleys for Draisine (Gondola with brakeman's cab) Ep.III-IV
Draisine Beiwagen (Hochbord mit Bremserhaus) Ep.III-IV

WB-566
Plat à ranchers Ep.III-IV
NOUVELLE RÉFÉRENCE



Trolleys for Draisine (Flat with racks) Ep.IV-V
Draisine Beiwagen (Flach mit Rungen) Ep.IV-V



WB-568

Type 1 Ep.V «SIMOTRA»
N° 33 87 690 1 959-1
Chargement CAILLOUX
FEUX FIN DE CONVOI FONCTIONNEL

*Typ 1 Ep.V «SIMOTRA» Stones load
Working rear headlights*

*Typ 1 Ep.V «SIMOTRA» Ladung Kieselsteine
mit funktionsfähigen Schlusslichtern*

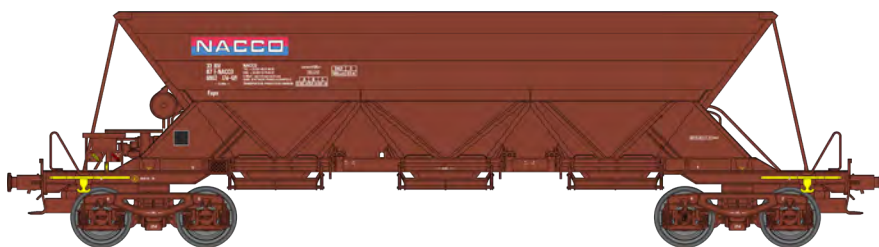

WB-569

Type 1 Ep.V «NACCO» N°33876902 174-6
Chargement CAILLOUX

Typ 1 Ep.V «NACCO» Stones load

Typ 1 Ep.V «NACCO» Ladung Kieselsteine



WB-570

Type 3 Ep.IV-V «CEWI» N°33876900 682-0
Chargement SABLE

Typ 3 Ep.IV-V «CEWI» Sand load

Typ 3 Ep.IV-V «CEWI» Ladung Sand



WB-571

Type 1 Ep.IV-V «SGTR» N°33876900574-9
Chargement SABLE

Typ 1 Ep.IV-V «SGTR» Sand load

Typ 1 Ep.IV-V «SGTR» Ladung Sand



WB-572

Type 1 Ep.IV-V «E^{ts} ROY et Fils»
N°33876900015-3
Chargement SABLE
FEUX FIN DE CONVOI FONTIONNEL

*Typ 1 Ep.IV-V «E^{ts} ROY et Fils» Sand load
Working rear headlights*

*Typ 1 Ep.IV-V «E^{ts} ROY et Fils» Ladung Sand
mit funktionsfähigen Schlusslichtern*



WB-573 SET de 3 wagons TRÉMIE EX Type 1 Ep.V «NACCO» - Chargement cailloux

Set of 3 T1 Ep.V «NACCO», stones load
Set aus 3 Typ 1 Ep.V «NACCO», Ladung Kieselsteine



WB-574 SET de 3 wagons TRÉMIE EX Type 1 et Type 3 Ep.IV-V «SGTR / CEWI / CEWI» - Chargement sable

Set of 3 T1 and T3 Ep.IV-V «SGTR / CEWI / CEWI», Sand load
Set aus 3 Typ 1 und 3 Ep.IV-V «SGTR / CEWI / CEWI», Ladung Sand



WB-575 SET de 3 wagons TRÉMIE EX Type 1 et Type 2 Ep.IV «E¹⁵ ROY et Fils / SIMOTRA» - Chargement sable

Set of 3 T2 Ep.IV «ROY & Fils / SIMOTRA», Sand load
Set aus 3 Selbstladewagen EX Typ 2 Ep.IV «ROY&Fils / SIMOTRA», Ladung Sand



WB-576 SET de 3 Wagons TRÉMIE EX Type 2 Ep.V «SIMOTRA» et «SIMOTRA - Carrière d'Arvel» - Chargement cailloux

Set of 3 T2 Ep.V «SIMOTRA» and «SIMOTRA - Carrière d'Arvel», Stones load
Set aus 3 Typ 2 Ep.V «SIMOTRA» und «SIMOTRA - Carrière d'Arvel», Ladung Kieselsteine

Trémie EX
Open hopper wagons with load · Selbstladewagen EX mit Ladung





WB-588

Citerne ANF courte,
bogie Y 25 Ep.IV-V
«ERMEFER»

*Short ANF Tank wagon, Y 25 bogie Ep.IV-V
«ERMEFER»*

*ANF Kesselwagen, kurz, Y 25 Drehgestelle,
Ep.IV-V «ERMEFER»*



WB-589

Citerne ANF courte
bogie Y 25 Ep.IV
«SIMOTRA-TOTAL»

*Short ANF Tank wagon, Y 25 bogie Ep.IV
«SIMOTRA-TOTAL»*

*ANF Kesselwagen, kurz, Y 25 Drehgestelle, Ep.IV
«SIMOTRA-TOTAL»*



WB-590

SET de 3 Citerne ANF courtes
bogie Y 25 Ep.IV
«SIMOTRA-TOTAL»

*Set of 3 Short ANF Tank wagon, Y 25 bogie
Ep.IV «SIMOTRA-TOTAL»*

*Set aus 3 ANF Kesselwagen, kurz, Y 25
Drehgestelle, Ep.IV «SIMOTRA-TOTAL»*





WB-591

Citerne ANF longue,
bogie Y 23M Ep.IV
«ALGECO-TOTAL»

*Long ANF Tank wagon, bogie Y 23M
Ep.IV «ALGECO-TOTAL»*

*ANF Kesselwagen, lang, Y 23M
Drehgestelle, Ep.IV «ALGECO-TOTAL»*



WB-592

Citerne ANF longue,
bogie Y 23M
Ep.V-VI «TOTAL»

*Long ANF Tank wagon, bogie Y 23M
Ep.V-VI «TOTAL»*

*ANF Kesselwagen, lang, Y 23M
Drehgestelle, Ep.V-VI «TOTAL»*



WB-593

Citerne ANF longue,
bogie Y 23M
Ep.V-VI «TOTAL»

*Long ANF Tank wagon, bogie Y 23M
Ep.V-VI «SIMOTRA»*

*ANF Kesselwagen, lang, Y 23M
Drehgestelle, Ep.V-VI «SIMOTRA»*



WB-595

Citerne ANF longue,
bogie Y 23M Ep.V-VI «VTG»

*Long ANF Tank wagon, bogie Y 23M
Ep.V-VI «VTG»*

*ANF Kesselwagen, lang, Y 23M
Drehgestelle, Ep.V-VI «VTG»*



WB-596

Citerne ANF longue,
bogie Y 23M Ep.V-VI «VTG»

*Long ANF Tank wagon, bogie Y 23M
Ep.V-VI «VTG»*

*ANF Kesselwagen, lang, Y 23M
Drehgestelle, Ep.V-VI «VTG»*



WB-597

Citerne ANF longue,
bogie Y 23M Ep.V-VI «ERMEWA»

*Long ANF Tank wagon, bogie Y 23M
Ep.V-VI «ERMEWA»*

*ANF Kesselwagen, lang, Y 23M
Drehgestelle, Ep.V-VI «ERMEWA»*



WB-594 - SET de 3 Citernes ANF longues bogie Y 23M Ep.V-VI «SIMOTRA» *Set of 3 Long ANF Tank wagons • Set aus 3 kesselwagen*



WB-598 - SET de 3 Citernes ANF longues bogie Y 23M Ep.V-VI «ERMEWA» *Set of 3 Long ANF Tank wagons • Set aus 3 kesselwagen*

Citerne ANF
ANF Tank wagons • ANF Kesselwagen



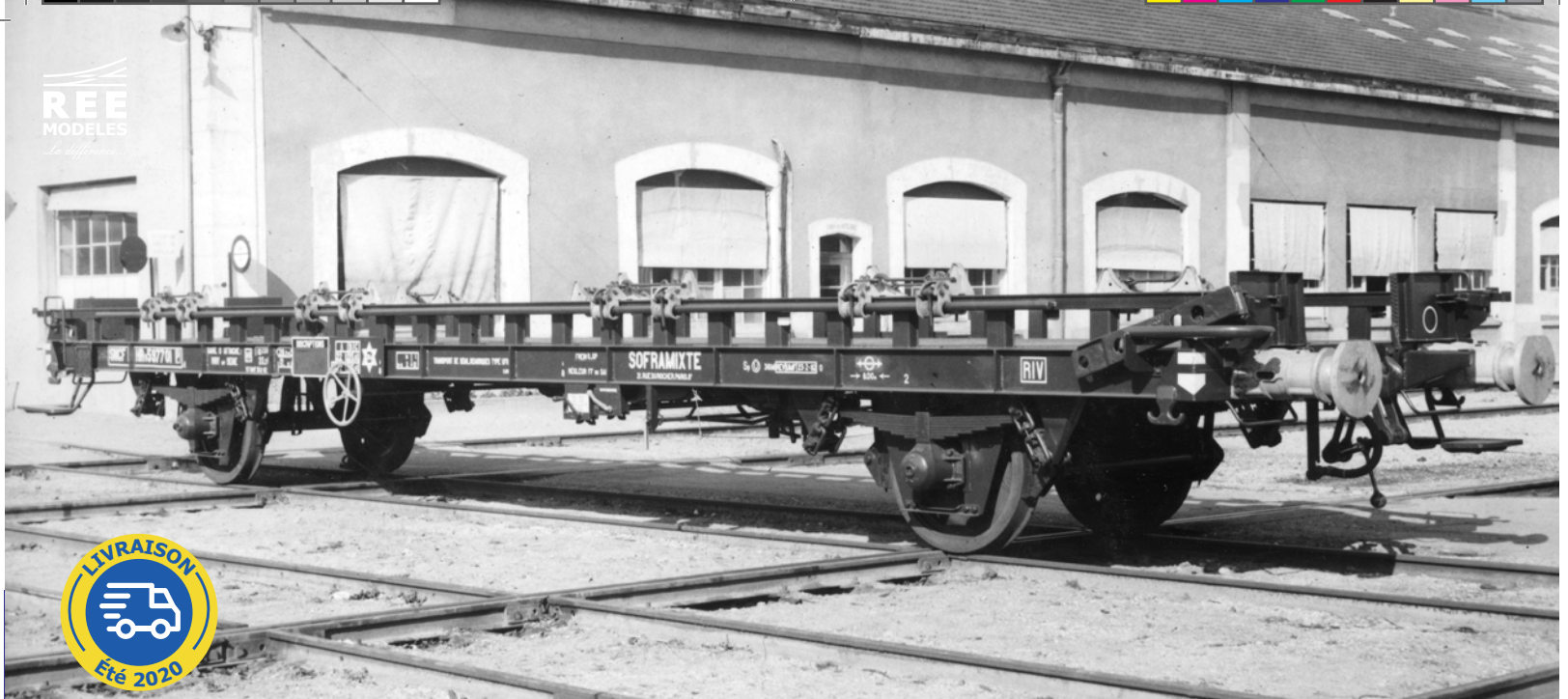

WB-613

Ep.III avec frein à vis HRv 598245 brun châssis noir + deux remorques citernes elliptiques BOURGEY-MONTREUIL

Ep.III with screw braking control, brown - black frame + 2 elliptical shaped tank trailers

Ep.III mit Handbremse, braun - Untergestell schwarz + zwei Tankaufliegerelliptisch



WB-614

Ep.III HR 598173 brun - châssis noir + 2 remorques citernes rondes CECI.

UFR double Wagon Ep.III HR 598173 brown - black frame + 2 round shaped tank trailers CECI

UFR Doppelträgerwagen Ep.III HR 598173 braun - Untergestell schwarz + zwei Tankauflieger rund CECI

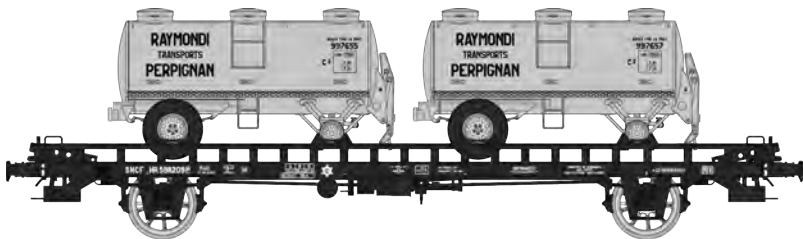

WB-615

Ep.III HR 598209 noir + 2 remorques citernes rondes RAYMONDI

UFR double Wagon Ep.III HR 598209 black + 2 round shaped tank trailers RAYMONDI

UFR Doppelträgerwagen Ep.III HR 598209 schwarz + 2 Tankauflieger rund RAYMONDI

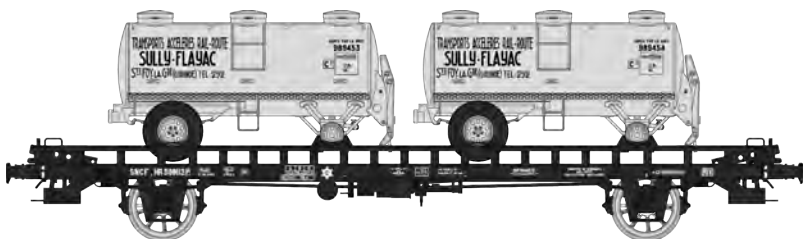

WB-616

Ep.III HR 598112 noir + 2 remorques citernes rondes SULLY-FLAYAC

UFR double Wagon Ep.III HR 598112 black + 2 round shaped tank trailers SULLY-FLAYAC

UFR Doppelträgerwagen Ep.III HR 598112 schwarz + 2 Tankauflieger rund SULLY-FLAYAC

WB-617

Ep.III HR 598191 brun - châssis noir
+ remorque fourgon à deux essieux SOBOTRAF

*Ep.III HR 598191 brown - black frame + 1 twin
axles van trailer SOBOTRAF*

*Ep.III HR 598191 braun - Untergestell schwarz + ein
Kastenaufleger 2-achsig SOBOTRAF*



WB-618

Ep.III avec frein à vis HRv 598257
brun - châssis noir
+ une remorque fourgon à deux
essieux PAVESI

*Ep.III with screw braking control, brown - black
frame + 1 twin axles van trailer PAVESI*

*Ep.III mit Handbremse, braun - Untergestell
schwarz + ein Kastenaufleger 2-achsig PAVESI*



WB-619

Ep.III avec frein à vis HRv 598284 brun -
châssis noir
+ remorque fourgon à deux essieux
BOURGEY-MONTREUIL

*Ep.III with screw braking control, brown - black frame
+ 1 twin axles van trailer BOURGEY-MONTREUIL*

*Ep.III mit Handbremse HRv 598284 braun
Untergestell schwarz + ein Kastenaufleger 2-achsig
BOURGEY-MONTREUIL*



WB-620

Ep.III avec frein à vis HRv 598290 brun
châssis noir + deux remorques fourgons
SOTRALEST

*Ep.III with screw braking control HRv 598290 brown
- black frame + 2 van trailers SOTRALEST*

*Ep.III mit Handbremse HRv 598290 braun -
Untergestell schwarz + zwei Kastenaufleger SOTRALEST*



WB-621

Ep.IV avec frein à vis 21870421098-6 rouge UIC
+ remorque fourgon à deux essieux WALBAUM

*Ep.IV with screw braking control 21 87 042 1 098-6
UIC red + twin axle van trailer WALBAUM*

*Ep.IV mit Handbremse 21 87 042 1 098-6 UIC rot
+ Kastenaufleger 2-achsig WALBAUM*



WB-622

Ep.IV 21 87 040 0 143-6 rouge UIC
+ deux remorques fourgons
SDTM + CALBERSON

*Ep.IV UIC red + twin axle van
trailer SDTM + CALBERSON*

*Ep.IV UIC rot
+ zwei Kastenaufleger SDTM + CALBERSON*





Heavy load Flat bed wagon SSy45 black with German bogie, SSyw 18444, Ep.III A
Schwerlastwagen SSy45 Schwarz mit deutschen Drehgestellen, SSyw 18444, Ep.III A

WBA-019

Porte-char SSy45 Noir avec bogie allemand, SSyw 18444, Ep.III A



Heavy load Flat bed wagon SSy45 black with German bogie, SSyw 18448, Ep.III A
Schwerlastwagen SSy45 Schwarz mit deutschen Drehgestellen, SSyw 18448, Ep.III A

WBA-020

Porte-char SSy45 Noir avec bogie allemand, SSyw 18448, Ep.III A



Heavy load Flat bed wagon SSy45 black with German bogie, SPyw 98769, Ep.III B
Schwerlastwagen SSy45 Schwarz mit deutschen Drehgestellen, SPyw 98769, Ep.III B

WBA-021

Porte-char SSy45 Noir avec bogie allemand, SPyw 98769, Ep.III B



Heavy load Flat bed wagon SSy45 black with German bogie, SPyw 99268, Ep.III B
Schwerlastwagen SSy45 Schwarz mit deutschen Drehgestellen, SPyw 99268, Ep.III B

WBA-022

Porte-char SSy45 Noir avec bogie allemand, SPyw 99268, Ep.III B



6 axes Heavy load Flat Wagon SSym46, black 99515, Ep.III A
Schwerlastwagen SSym46, Schwarz 6-achsige, 99515, Ep.III A

WBA-027

Porte-char SSym46, Noir avec 6 essieux, 99515, Ep.III A



6 axes Heavy load Flat Wagon SSym46, black, 99596, Ep.III B
Schwerlastwagen SSym46, Schwarz 6-achsige, 99596, Ep.III B

WBA-028

Porte-char SSym46, Noir avec 6 essieux, 99596, Ep.III B



AB-023 - Char AMX 30D Dépanneur 1DB / 6^{ème} Dragons ECS «PORTHOS»
AMX 30D ARV
Abschlepppanzer AMX 30D



AB-024 - Char AMX 30B - 1DB / 6^{ème} Dragons
1^{er} Esc «ARTOIS» N°141
AMX 30B MBT
Panzer AMX 30B



WBA-012

Rlmmp 31 87 389 1 087-2 SNCF
Ep.IV brun, avec bogie SNCF Y27
+ Char AMX 30D Dépanneur
1DB / 6^{ème} Dragons ECS «ATHOS»

*Rlmmp, SNCF Ep.IV brown with SNCF Y27 bogie +
AMX 30D ARV - 1DB / 6^{ème} Dragons ECS «ATHOS»*

*Rlmmp, SNCF Ep.IV braun, mit SNCF Y27
Drehgestelle + Abschlepppanzer AMX 30D - 1DB /
6^{ème} Dragons ECS «ATHOS»*



WBA-023

Rlmmp 31 87 389 1 087-2 SNCF Ep.IV
brun, avec bogie SNCF Y27
+ Char AMX 30B
1DB/6^{ème} Dragons 1^{er} Esc «ANJOU» N°112

*Rlmmp, SNCF Ep.IV brown with SNCF Y27 bogie +
AMX 30B MBT - 1DB/6^{ème} Dragons 1^{er} Esc «ANJOU»
N°112*

*Rlmmp, SNCF Ep.IV braun, mit SNCF Y27 Drehgestelle
+ Panzer AMX 30B - 1DB/6^{ème} Dragons 1^{er} Esc
«ANJOU» N°112*



WBA-024

Rlmmp 31 87 389 1 234-0 SNCF Ep.IV brun,
avec bogie SNCF Y27 + Char AMX 30B -
1DB/6^{ème} Dragons 1^{er} Esc «BRETAGNE»
N°111

*Rlmmp, SNCF Ep.IV brown, with SNCF Y27 bogie + AMX
30B MBT - 1DB / 6^{ème} Dragons 1^{er} Esc «BRETAGNE»
N°111*

*Rlmmp, SNCF Ep.IV braun, mit SNCF Y27 Drehgestelle
+ Panzer AMX 30B - 1DB / 6^{ème} Dragons 1^{er} Esc
«BRETAGNE» N°111*



WBA-025

Rlmmp, 31 87 389 1 171-4 SNCF
Ep.IV brun, avec bogie SNCF Y27 +
Char AMX 30B - 1DB / 6^{ème} Dragons
3^{ème} Esc «MASSENA» N°333

*Rlmmp, SNCF Ep. brown, with SNCF Y27 bogie + AMX
30B MBT - 1DB / 6^{ème} Dragons 3^{ème} Esc «MASSENA»
N°333*

*Rlmmp, SNCF Ep.IV braun, mit SNCF Y27 Drehgestelle
+ Panzer AMX 30B - 1DB / 6^{ème} Dragons 3^{ème} Esc
«MASSENA» N°333*



WBA-026

Rlmmp 31 87 389 1 072-4 SNCF
Ep.IV brun, avec bogie SNCF Y27 +
Char AMX 30B - 1DB / 6^{ème} Dragons
1^{er} Esc «LORRAINE» N°141

*Rlmmp, SNCF Ep.IV brown, with SNCF Y27 bogie + AMX
30B MBT - 1DB / 6^{ème} Dragons 1^{er} Esc «LORRAINE»
N°141*

*Rlmmp SNCF Ep.IV braun, mit SNCF Y27 Drehgestelle
+ Panzer AMX 30B - 1DB / 6^{ème} Dragons 1^{er} Esc
«LORRAINE» N°141*



Plat AMX 30
French army - Französische Streitkräfte

by **Artitec**®





CB-120
Autocar vert et crème - Transports B Gonthier - Périgueux (24)



CB-121
Autocar jaune et blanc - SNCF - Service Rodez - Séverac (81)



CB-122
Autocar orange et gris - Transports Mèresse - Iwuy (59)

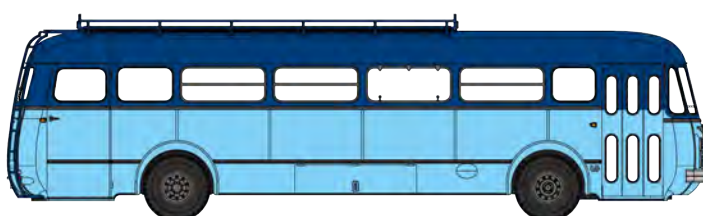

CB-123
Autocar bleu clair / bleu foncé - Anonyme (66)

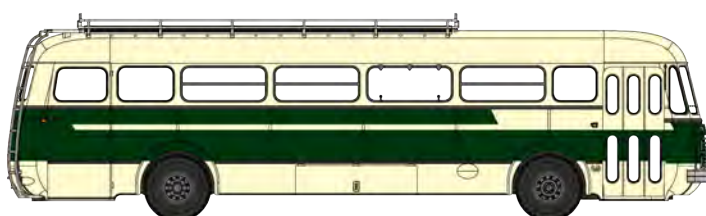

CB-124
Autocar vert et crème - Transports Gras - Libos (47)

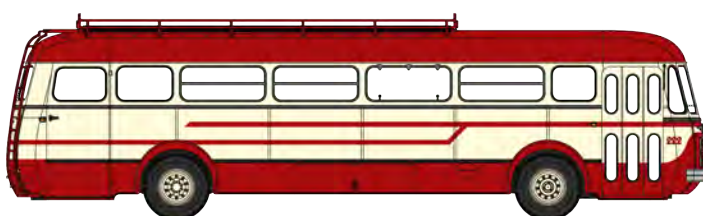

CB-125
Autocar rouge et crème - Transports Mousset - Longwy (54)



CB-126
Autocar bleu - Publicité Orangina - Hyères - Toulon (83)



CB-127
Autocar vert et crème - Publicité Néocide - SGTD (75)



CB-129
Autocar vert et crème - Publicité Maizena - RATP - Ligne 258 (75)



CB-129
Autocar vert et crème - RATP - Publicité Dubonnet - Ligne 262 (75)



CB-065 - Benne «COLAS»



CB-067 - Porte-Grumes «Jules Gendre»



CB-069 - Citerne à vin «PRIMIOR»



CB-070 - Citerne à vin + remorque rouge (Préserver par M.Michel)



CB-072 - Citerne à vin «MARGNAT»



CB-071 - Citerne à vin + remorque «Loubet & Cie»



CB-074 - Tracteur Willeme et remorque kangourou «O.G.T.»



CB-101 - Bâché du Film «GAS-OIL» avec Jean Gabin

CB-102 - Bâché "Joseph Vallier - Transport Cours"



CB-103 - Primeur "Groupage et Affrètements en France"



CB-104 - Camion Willeme Primeur



CB-105 - Camion Willeme Bâché "VILLEROY & BOCH"



CB-106 - Bleu Bâché + remorque



CB-107 - Bâché + remorque bâché "ENERGOL"





Camion Panhard



CB-045 - Bétaillère Petits Animaux Grise et Marron



CB-091 - Plateau - Chargement de sacs de Charbon



CB-096 - Citerne à Vin de Touraine « Pierre Aubert »



CB-097 - Panhard Movic Citerne à Vin

CB-098 - Citerne à Vin + Remorque « LOUIS CHARLES » Béziers



CB-099 - Citerne à Vin + Remorque « Ets GRASSET » Asnières



CB-100 - Citerne à Vin + Remorque (Bleu et Gris)





CB-055 - Dépanneuse CHEVROLET 3T



CB-057 - Chevrolet 3T à Ridelles



CB-058 - Chevrolet 3T à Ridelles

C.C.F.L Camion Citerne Lourd pour Feux de Forêt "Froger"
Citerne de 3.500 Litres - Moto-pompe de 30 m³
JEEP C.C.F Léger pour Feux de Forêt - Motopompe Guinard de 6 m³/h



CB-075 - GMC Cabine tôle «INGUINIEL»



CB-076 - GMC «St-GEORGES-SUR-LOIRE»



CB-077 - GMC Cabine tôle «ROUEN»



CB-078 - GMC «ALPES-MARITIMES»



CB-079 - GMC «PAIMPOL»



CB-080 - GMC «COGOLIN»



CB-081 - GMC «GRIMAUD»



CB-082 - GMC «LODÈVE»



CB-083 - GMC «COUTANCES»



CB-084 - GMC «CHARENTE MARITIME»



CB-086 - Bande blanche & motopompe



CB-088 - Ville de Fumay



CB-089 - N°226 sur capot avant



CB-090 - Ville de Damery avec échelle



CB-108 - GLC 6 à plateau

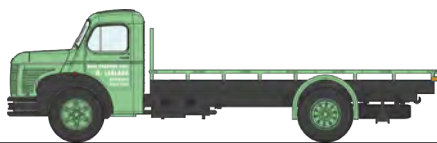

CB-109 - GLC 6 à plateau
+ Chargement Sacs de Charbon



CB-110 - GLC 6 à ridelles

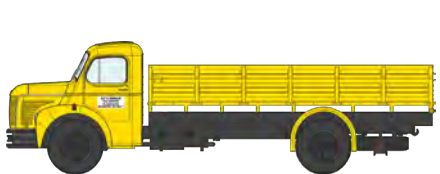

CB-111 - GLC 6 ridelles
+ chargement entreprise de Maçonnerie



CB-112 - GLC 6 bétailière



CB-113 - GLC 6 Bétailière «LEVAUX»



CB-114 - GLC 6 Fourgon tôle «GRINGOIRE»



CB-115 - GLC 6 Fourgon tôle «LUMIÈRE»



CB-116 - GLC 6 Fourgon tôle «FLORALINE»



CB-117 - GLC 6 Fourgon tôle
«TRANSPORT ELBEUVIEN»



CB-118 - GLC 6 Fourgon bois
«MESSAGERIE du BLAYAIS»



CB-119 - GLC 6 Fourgon bois
«TRANSPORT ARNOUD»





REE Modèles créé, en partenariat avec Architecture & Passion, la gamme « Les secondaires » dédiée à la reproduction des modèles en voie métrique et voie étroite en HOm et HOe. Le premier modèle de cette nouvelle marque est l'autorail BILLARD A80-D, construit à partir de 1936 par les établissements BILLARD à Tours.

Ce modèle dispose de feux fonctionnels, d'un éclairage intérieur et d'une sonorisation réaliste enregistrée sur le Chemin de Fer du Vivarais (*sur les modèles DCC Sound*). LIVRAISON : PRINTEMPS 2020

Billard CFD n°313

2 phares, Rouge et Gris perle
Époque III
VM-001 - Analogique
VM-001 S - DCC Sound



Billard CFD n°314

2 phares, Rouge et Gris perle
Époque III
VM-002 - Analogique
VM-002 S - DCC Sound



Billard CFV n°316

2 phares, Rubis et Crème
Toit alu. - Touristique
Époque IV
VM-003 - Analogique
VM-003 S - DCC Sound



Billard CFV n°316

2 phares, Rouge et Gris
Touristique
Époque IV-V
VM-004 - Analogique
VM-004 S - DCC Sound





À l'étude

Locotracteur de type BB équipé de deux moteurs de 200cv.

LIVRAISON : 2021

BB-040-003
CFD du Vivarais
VM-022 - Analogique
VM-022 S - DCC Sound

BB-401 du Paris-Orléans-Corrèze
Dépôt de Tulle
VM-023 - Analogique
VM-023 S - DCC Sound

BB-402
Chemin de Fer de Provence
VM-024 - Analogique
VM-024 S - DCC Sound

BB-405 CFC Chemin de Fer de Corse - Couleur d'origine
VM-025 - Analogique
VM-025 S - DCC Sound





Set de 2 wagons couverts freinés, toit rond, gris, ferrures noires, Kv 4096 et Kv 4100
VM-009



Set de 2 wagons couverts freinés, toit rond, gris foncé, Kv 4091 et Kv 4627
VM-010



Set de 2 wagons couverts freinés, toit rond, rouge UIC, Kv 4624 et OREZZA Kv 4609
VM-011



Set de 2 wagons couverts freinés, toit rond, rouge UIC, Kv 4622 et MATTEI Kv 4614
VM-012



Set de 2 couverts freinés, toit rond, gris foncé, Kv 4631 et gris, ferrures noires Kv 4088
VM-013



Tous les wagons sont vendus avec des essieux pour les deux écartements HOm et HOe.

LIVRAISON : 1^{er} TRIMESTRE 2020



Set de 2 tombereaux freinés, Gv 5636 et barre de faitage, Gv 5686, gris, ferrures noires VM-014



Set de 2 tombereaux freinés, Gv 5645 et barre de faitage, Gv 5792, gris foncé VM-015



Set de 2 tombereaux sans freins, barre de faitage, gris foncé, Gv 5199, et gris, ferrures noires, G 239 VM-016



Set de 2 tombereaux freinés, rouge UIC, Gv 5816 et barre de faitage, brun, Gv 5855 VM-017



Set de 2 plats freinés, gris, ferrures noires, Hv 6596 et Hv 6600 VM-018



Set de 2 plats freinés, gris foncé, Hv 6592 et Hv 6181 VM-019



Set de 2 plats sans freins, gris, ferrures noires, H 6194 et freiné gris foncé Hv 6598 VM-020



Set de 2 plats freinés, bruns, Hv 5736 et Hv 6602 VM-021



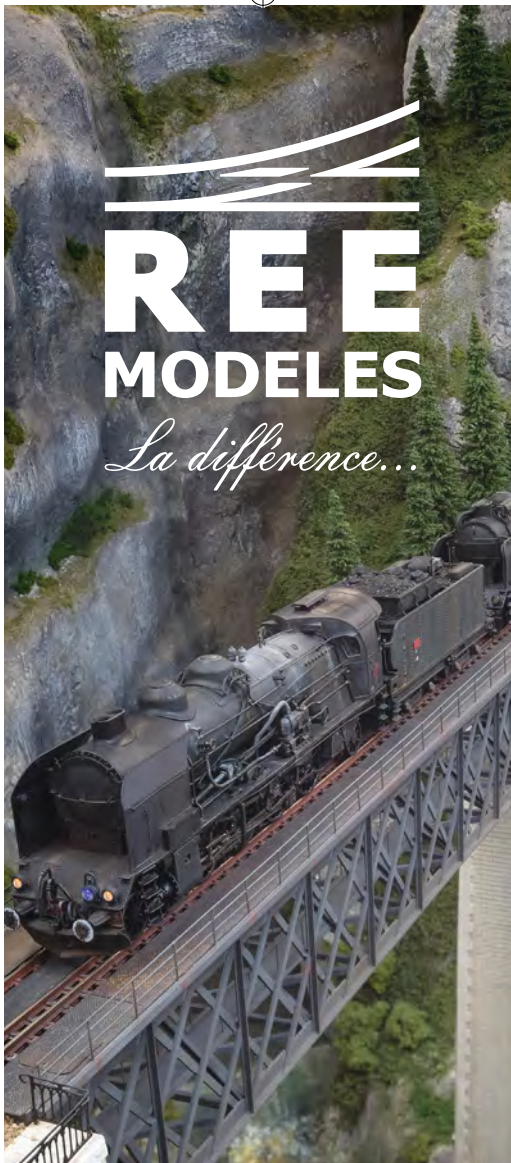

REE MODELES

La différence...

www.ree-modeles.com

Suivez-nous sur :    

VOTRE REVENDEUR



RAILS EUROP EXPRESS
46, route de Paris - 77370 NANGIS
Tél. : +33 (0)1 64 00 31 20
Commercial : info@ree-modeles.com

SAV : sav@ree-modeles.com • Tél. : +33 (0)1 60 58 60 60

*Sous réserve de modifications et de disponibilité. Caractéristiques et dimensions sous toutes réserves. Sous réserve d'erreurs de typographie et d'erreurs d'impression, toute responsabilité est ici exclue. Certaines illustrations montrent des modèles non définitifs dans les détails; la production en série peut diverger des modèles illustrés.
Crédit photos : Dominique BURAUD, Pierre BARBE, Benoît DELAHAYE, Daniel CABANE, Jean-Marc STEINER, Jean-Paul GEAI, Jean BUCHMANN, Olivier TANIQUO, Collection REE
Catalogue imprimé en France • Janvier 2020*

Rails Europ Express - SAS au capital de 220.000 € - RCS Annecy 507 656 916. Tous droits réservés. Copie interdite, même partielle.

Réalisation : OVM Communication • www.ovm-communication.fr 